

## Need more help?

### No TV or Internet service:

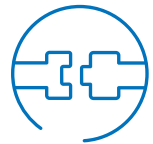

#### Check your connections:

Cables usually make an audible click when secure.

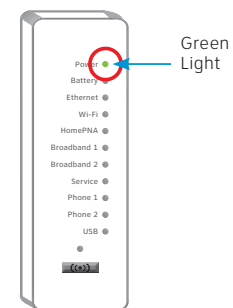

Front View

**Check Power:** Power light on the Wi-Fi Gateway should be green; if not, try another electrical outlet

**Check Service light on front of the Wi-Fi Gateway:** If after 5 minutes, the light is red or off, power down the Wi-Fi Gateway by holding down red reset button for 15 seconds.

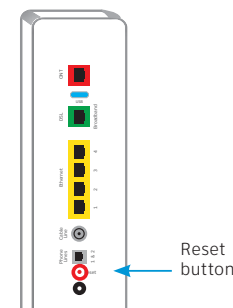

Back View

**TV Receivers not responding:** Confirm Service light is solid green on the Wi-Fi Gateway. If so, hold the TV receiver's power button down for 10 seconds and release, then wait five minutes.

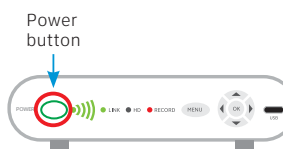

**If your existing Wi-Fi settings did not transfer you will need to setup a new Wi-Fi Network Name and Password. To do so follow these steps:**

- Use settings from new Wi-Fi Gateway yellow sticker
- Open your device's Wi-Fi connection settings, select your Wi-Fi Network Name and enter Wi-Fi Password to connect
- Record and keep your Wi-Fi settings for future reference when connecting all your Wi-Fi devices

**Wi-Fi Network Name:** ATTXXXXXXXX  
**Wi-Fi Password:** XXXXXXXXXXXX

For help, att.com/support

**Wi-Fi Gateway power light is amber:** Don't worry. This is a normal part of the power up sequence.

**Additional assistance:** call 800.288.2020 and ask for "technical support"

# AT&T Wi-Fi® Gateway Replacement

self-  
installation  
guide



## Get the most from AT&T Fiber<sup>SM</sup> and find out what it can do for you.

Go to [att.com/fibersupport](http://att.com/fibersupport) to find answers to frequently asked questions.

- **Internet Speed:** How do I improve my speed?
- **U-verse TV:** How AT&T Fiber makes your U-verse TV experience better?
- **More Support:** Having trouble with your Fiber connection?

## Additional information

### Test your Internet connection speed:

Our speed test takes less than a minute to perform two key measurements (Download and Upload) to help you determine if you should take steps to improve the performance of your online experience: Visit [att.com/speedtest](http://att.com/speedtest).

### Manage your account:

Available 24/7, download the myAT&T app at [att.com/myattapp](http://att.com/myattapp) from your mobile device.

### Support:

- For support, including live chat, go to [att.com/support](http://att.com/support)

### Repair Center:

Phone: 800.246.8464

### IPv6

AT&T supports IPv6 across our network, equipment and devices. Visit [att.com/ipv6](http://att.com/ipv6) for more information.

### Accessibility Support:

- Alternate formats now available in Large Print or Braille. Call 800.288.2020 and request your guide number (ATT142960896-3)
- Telephone equipment for visual and/or hearing impaired:
  - Phone: 877.902.6350
  - TTY: 800.772.2889
- Repair Center:
  - Phone: 800.246.8464
  - TTY: 800.397.3172
- Accessible Tagged PDF: Visit [att.com/userguides](http://att.com/userguides)
- Compatible with any TTY/TDD devices with standard phone line

### ¿Habla español?

Para ver a esta guía en español, visita [att.com/guias](http://att.com/guias) y haz clic en la pestaña Internet. Desplázate hacia abajo a donde dice "Guía de Reemplazo" y elije [ATT142960896-3]

## Get started

Total approximate installation time: 20 minutes

These instructions will guide you through the process of replacing your Wi-Fi Gateway.

In the box:

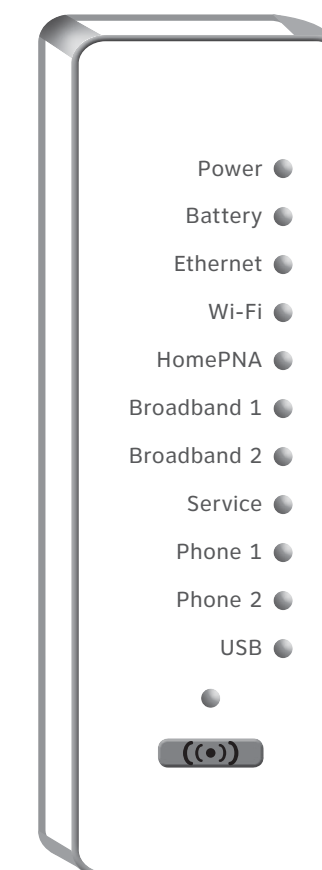

Wi-Fi Gateway  
(Front View)

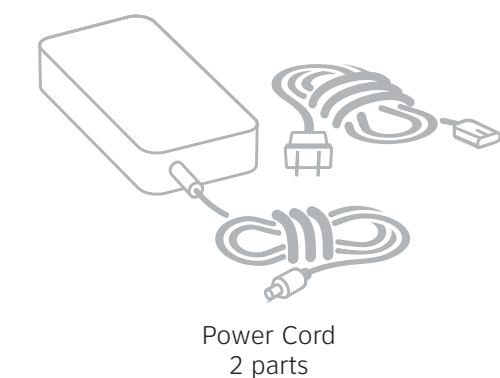

Power Cord  
2 parts



# 1. Set up

Approximate time: 10 minutes

**!** Please note that your U-verse TV, Internet, and phone services will not operate during this process. This includes recording TV shows.

- A.**
  - Unplug power cord from existing Wi-Fi Gateway
  - Set power cord aside
  - Stand new Wi-Fi Gateway side-by-side with existing Wi-Fi Gateway
- B.**
  - Transfer one connection at a time from the existing Wi-Fi Gateway to new Wi-Fi Gateway
- C.**
  - Carefully read and remove yellow power sticker covering the Power port of new Wi-Fi Gateway
  - Connect new power cord to power port of new Wi-Fi Gateway and into electrical outlet

Below is a completed setup. Your connections may vary.

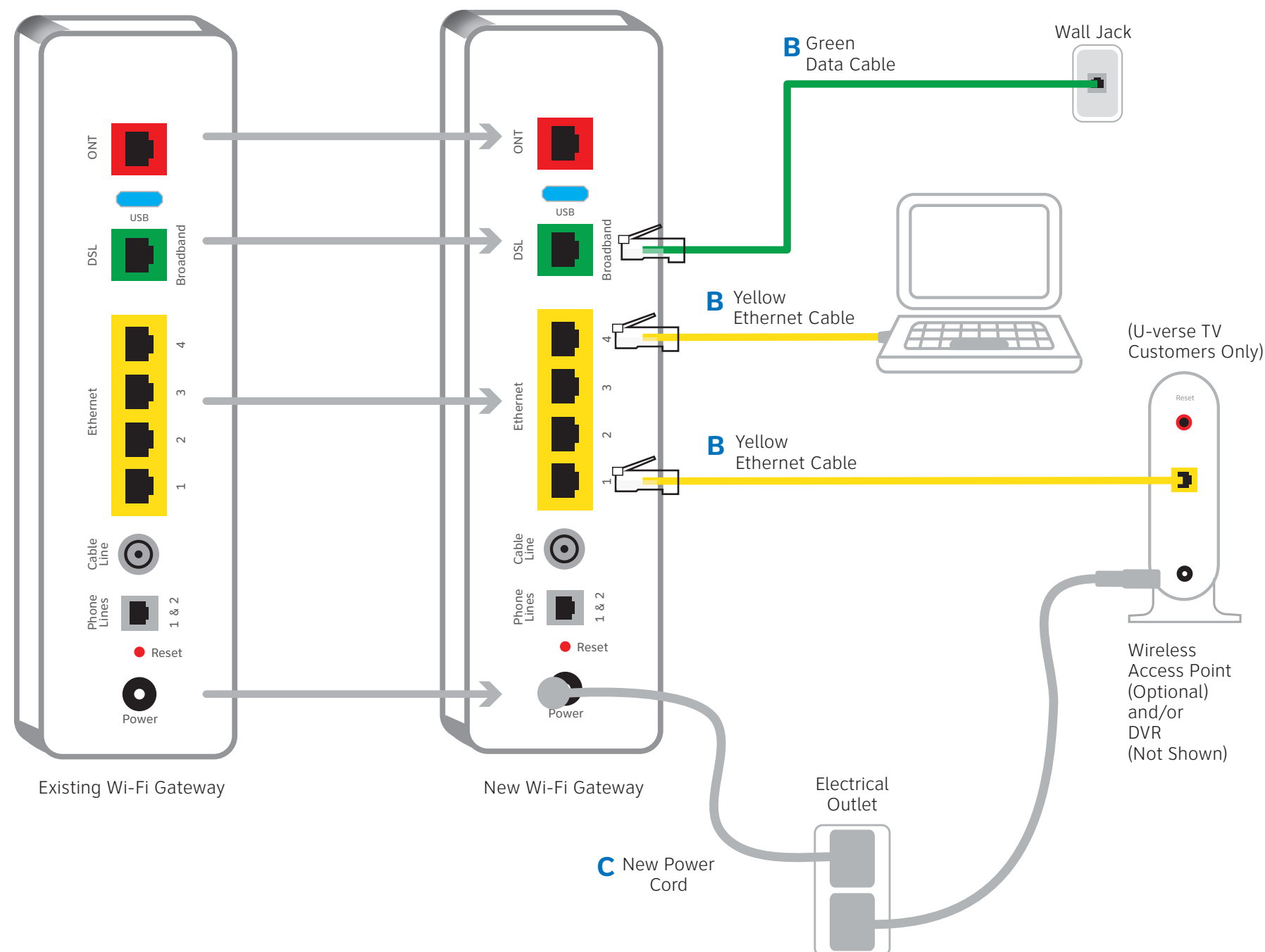

# 2. Power up

Approximate time: 1–5 minutes

**!** Your Wi-Fi Gateway is now powering up. During this time (up to 5 minutes), do not unplug the power cord or the green data cable, as this can permanently damage the Wi-Fi Gateway and significantly delay your service activation.

When complete, the Service light will begin flashing, then turn to solid green.

If the Service light does not turn solid green or continues to blink after 5 minutes, see **Need more help?** on the back of this guide.

**NOTE:** Your TV may take a few minutes to display. Check your TV for service. If your TV does not respond, refer to **Need more help?** on the back of this guide.

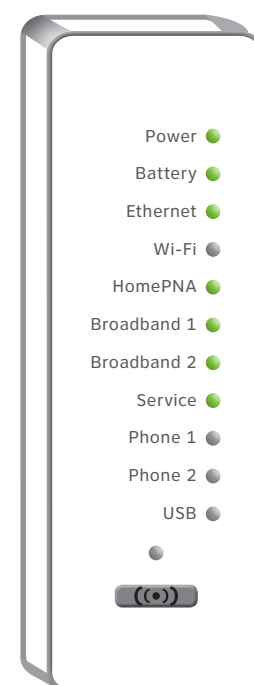

Lights may vary with setup.

# 3. Go Wi-Fi

Approximate time: 1–5 minutes

## New Wi-Fi setup:

**A.** Select only one option to begin the Wi-Fi setup.

### Option 1: Connect using PC

- Connect laptop or PC with an Ethernet cable to your Wi-Fi Gateway
- Continue to **B**

### Option 2: Connect using smartphone/tablet

- Establish a temporary connection using new Wi-Fi settings located on yellow sticker on new Wi-Fi Gateway
- Open your device's Wi-Fi connection settings and select your Wi-Fi Network Name and enter your Wi-Fi Password to connect to your network
- Continue to **B**

## B.

**Note:** Please wait up to 10 minutes for the Wi-Fi Gateway to complete the power up process before attempting to restore your settings.

- Open a browser and go to [ufix.att.com/restore](http://ufix.att.com/restore)
- Log in to your AT&T account. If you forgot your User ID (primary AT&T email address) and Password, help can be found on the account log in screen.
- Follow the on screen instructions to transfer the existing Wi-Fi settings.
- Record existing Network Name and Wi-Fi Password on separate yellow sticker from kit.
- Place new yellow sticker over your new Wi-Fi Gateway's yellow sticker.

**!** **NOTE:** If Wi-Fi settings did not transfer or to use new Wi-Fi Network Name and Password, refer to **Need more help?** section on back page of guide.

**!** **NOTE:** Any custom settings made for security cameras, game consoles, etc., on your original Wi-Fi Gateway will also need to be made on your new Wi-Fi Gateway.

# 4. Easy return

(Refer to return instructions in your kit)

- A.** Return your equipment at no cost to you within 21 days to avoid \$150 charge.
- B.** Take original gateway and power cord to nearest The UPS Store. Bring your AT&T Account number located on your packing slip. Please do not return other devices (e.g., backup battery, etc.).
- C.** UPS will scan your equipment, provide a receipt, pack, and ship equipment to AT&T at no cost to you.

