

# Lenovo 100e/300e/500e Chromebook Gen 3 User Guide



**Lenovo**

## **Read this first**

Before using this documentation and the product it supports, ensure that you read and understand the following:

- *Safety and Warranty Guide*
- *Setup Guide*
- [Generic Safety and Compliance Notices](#)

**First Edition (April 2021)**

**© Copyright Lenovo 2021.**

LIMITED AND RESTRICTED RIGHTS NOTICE: If data or software is delivered pursuant to a General Services Administration "GSA" contract, use, reproduction, or disclosure is subject to restrictions set forth in Contract No. GS-35F-05925.

---

# Contents

Discover your Chromebook . . . . .	ii	Set the power plan . . . . .	14
<b>Chapter 1. Meet your Chromebook . . . . .</b>	<b>1</b>	Shut down your Chromebook . . . . .	14
Front view . . . . .	1	<b>Chapter 3. CRU replacement . . . . .</b>	<b>17</b>
Side view . . . . .	3	What are CRUs . . . . .	17
Bottom view . . . . .	5	Replace a CRU . . . . .	17
Rear view . . . . .	5	Pen dummy . . . . .	17
Specifications . . . . .	5	Base cover assembly . . . . .	18
USB specifications . . . . .	5	<b>Chapter 4. Help and support . . . . .</b>	<b>21</b>
<b>Chapter 2. Explore your Chromebook . . . . .</b>	<b>7</b>	Frequently asked questions . . . . .	21
Charge your Chromebook . . . . .	7	Call Lenovo . . . . .	21
Lock your Chromebook . . . . .	7	Before you contact Lenovo . . . . .	21
Connect to a cellular network (for selected models) . . . . .	8	Lenovo Customer Support Center . . . . .	22
Interact with your Chromebook . . . . .	8	Get help from Google . . . . .	23
Use the keyboard shortcuts . . . . .	9	<b>Appendix A. Compliance information . . . . .</b>	<b>25</b>
Use the touchpad . . . . .	9	<b>Appendix B. Open source information . . . . .</b>	<b>31</b>
Use the touch screen (for Lenovo 300e/500e Chromebook Gen 3 only) . . . . .	10	<b>Appendix C. Notices and trademarks . . . . .</b>	<b>33</b>
Use the electronic pen (for selected models of Lenovo 300e/500e Chromebook Gen 3) . . . . .	12		
Get to know your Chromebook modes (for Lenovo 300e/500e Chromebook Gen 3) . . . . .	12		
Connect to an external display . . . . .	13		

---

## Discover your Chromebook

**Thank you for choosing a Lenovo® Chromebook™! We are dedicated to delivering the best solution to you.**

Before starting your tour, please read the following information:

- Illustrations in this documentation might look different from your product.
- Depending on the model, some optional accessories, features, software programs, and user interface instructions might not be applicable to your Chromebook.
- Documentation content is subject to change without notice. To get the latest documentation, go to <https://pcsupport.lenovo.com>.

---

# Chapter 1. Meet your Chromebook





---

## Front view

Lenovo 100e Chromebook Gen 3



---

	Camera		Webcam privacy shutter
	Microphone		Power button
	Touchpad		

---

## Lenovo 300e/500e Chromebook Gen 3



	Camera*		Webcam privacy shutter
	Microphone*		Touch screen
	Touchpad		

\* for selected models



### Webcam privacy shutter

Slide the webcam privacy shutter to cover or uncover the camera lens. It is designed to protect your privacy.

### Related topics

- “Use the touch screen (for Lenovo 300e/500e Chromebook Gen 3 only)” on page 10
- “Get to know your Chromebook modes (for Lenovo 300e/500e Chromebook Gen 3)” on page 12
- “Use the touchpad” on page 9





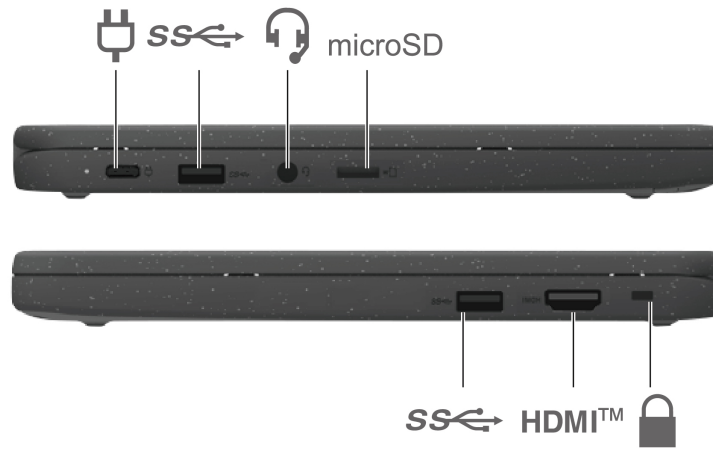

## Side view

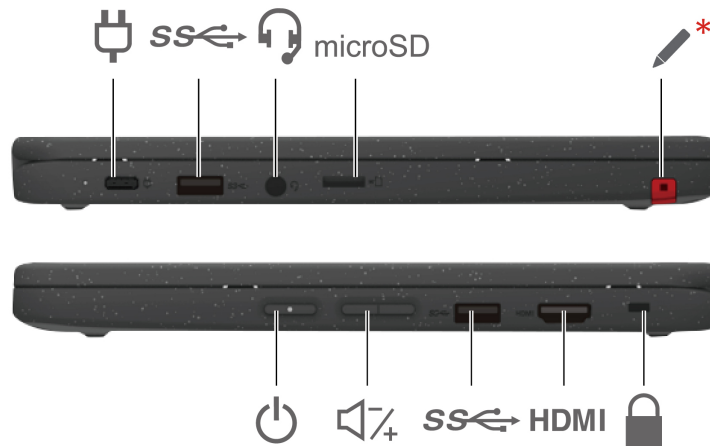
### Lenovo 100e Chromebook Gen 3



### Lenovo 300e/500e Chromebook Gen 3



	USB-C® (3.2 Gen 1) power connector		USB 3.2 connector Gen 1
	Audio connector		Security-lock slot
	Electronic pen*		Volume buttons
	Power button		

\* for selected models

**Related topics**

- “Charge your Chromebook” on page 7
- “USB specifications” on page 5
- “Use the electronic pen (for selected models of Lenovo 300e/500e Chromebook Gen 3)” on page 12
- “Lock your Chromebook” on page 7
- “Connect to an external display” on page 13



---

## Bottom view

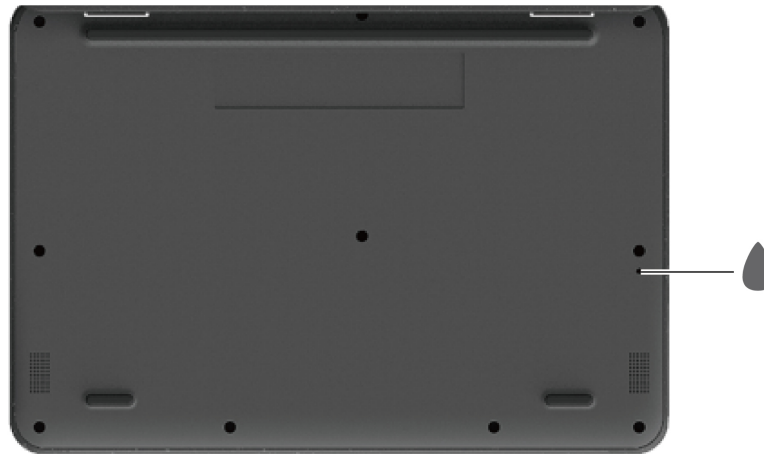

Keyboard drainage hole

---



### Keyboard drainage hole

Drain out liquid from your Chromebook if you accidentally spill liquid on the keyboard.

---

## Rear view



Nano-SIM-card tray\*

---

\* for selected models

---

## Specifications

For detailed specifications of your Chromebook, go to <https://psref.lenovo.com>.

### USB specifications

**Note:** Depending on the model, some USB connectors might not be available on your Chromebook.

Connector name	Description
----------------	-------------

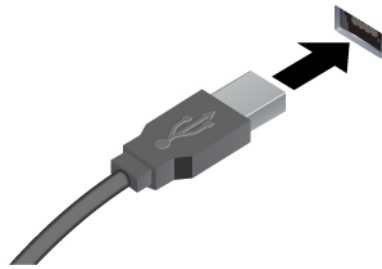

Connect USB-compatible devices, such as a USB keyboard, USB mouse, USB storage device, or USB printer.

 USB 3.2 connector Gen 1

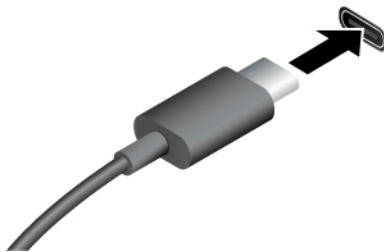

USB-C (3.2 Gen 1) connector

- Charge USB-C compatible devices with the output voltage and current of 5 V and 1.5 A.
- Connect to an external display:
  - For Lenovo 100e/300e Chromebook Gen 3:
    - USB-C to VGA: up to 1900 x 1200 pixels, 60 Hz
    - USB-C to DP: up to 3840 x 2160 pixels, 30 Hz
  - For Lenovo 500e Chromebook Gen 3:
    - USB-C to VGA: up to 1980 x 1200 pixels, 60 Hz
    - USB-C to DP: up to 4096 x 2160 pixels, 60 Hz
- Connect to USB-C accessories to help expand your Chromebook functionality. To purchase USB-C accessories, go to <https://www.lenovo.com/accessories>.

### Statement on USB transfer rate

Depending on many factors such as the processing capability of the host and peripheral devices, file attributes, and other factors related to system configuration and operating environments, the actual transfer rate using the various USB connectors on this device will vary and will be slower than the data rate listed below for each corresponding device.

USB device	Data rate (Gbit/s)
3.2 Gen 1 / 3.1 Gen 1	5
3.2 Gen 2 / 3.1 Gen 2	10
3.2 Gen 2 × 2	20
Thunderbolt 3	40
Thunderbolt 4	40

---

## Chapter 2. Explore your Chromebook

---

### Charge your Chromebook

Power source of the ac power adapter:

- Power: 45 W or 65 W (depending on the model)
- Sine-wave input at 50 Hz to 60 Hz
- Input rating of the ac power adapter: 100 V to 240 V ac, 50 Hz to 60 Hz

**CAUTION:**

**All plugs must be firmly and securely inserted into receptacles.**

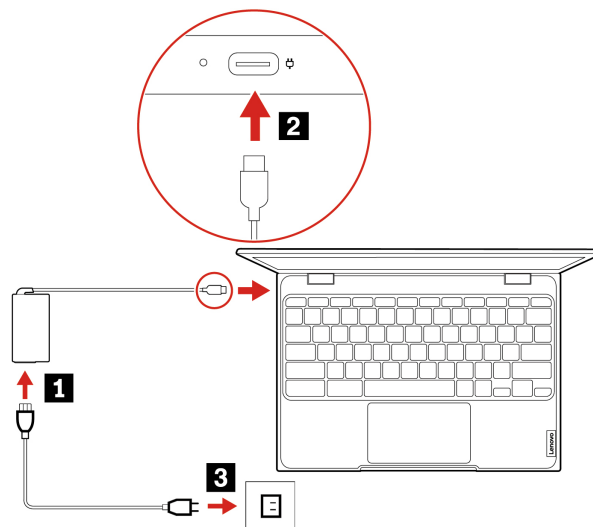

---

### Lock your Chromebook

Lock your Chromebook to a desk, table, or other fixtures through a compatible security cable lock.

**Note:** The slot supports cable locks that conform to the Kensington NanoSaver® lock standards using Cleat™ locking technology. You are responsible for evaluating, selecting, and implementing the locking device and security feature. Lenovo is not responsible for the locking device and security feature. You can purchase the cable locks at <https://smartfind.lenovo.com>.

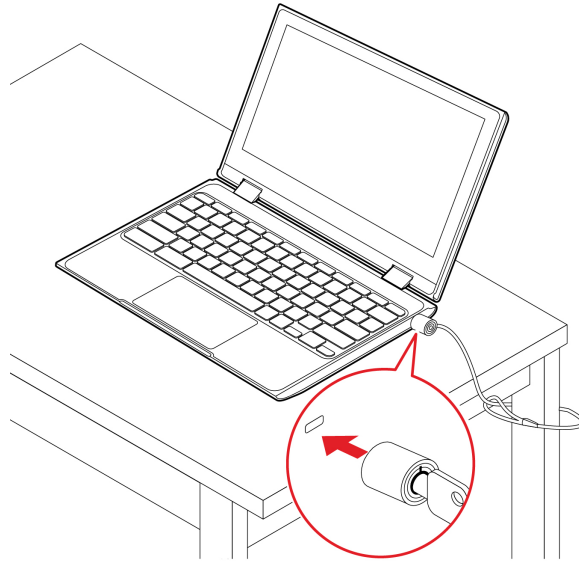

---

## Connect to a cellular network (for selected models)

If your Chromebook has a wireless wide area network (WAN) card and a nano-SIM card installed, you can connect to a cellular data network and get online everywhere.

**Note:** The cellular service is provided by authorized mobile service carriers in some countries or regions. You must have a cellular plan from a service carrier to connect to the cellular network.

To establish a cellular connection:

1. Turn off the Chromebook.
2. Locate the nano-SIM card slot and insert the nano-SIM card as shown. Note the orientation of the card and ensure that it is seated correctly.

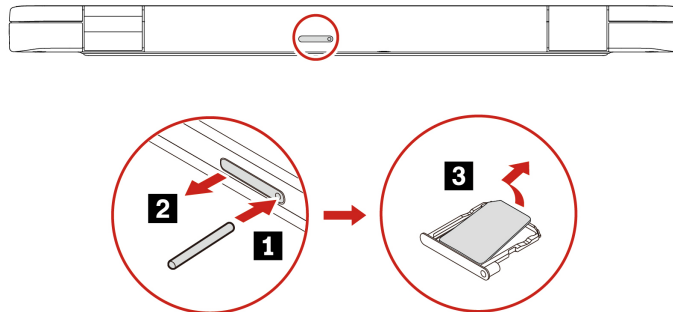

3. Turn on the Chromebook.
4. Click the network icon in the system tray, and then turn on **Mobile data**. Provide required information, if needed.











---

## Interact with your Chromebook

This section introduces various ways to interact with your Chromebook.





## Use the keyboard shortcuts

The function keys on the keyboard help you work more easily and effectively.

	Refresh your current page.
	Make the current window full screen.
	Open the task view to see all your open windows.
	Darken the display.
	Brighten the display.
	Mute the speakers.
	Decrease the speaker volume.
	Increase the speaker volume.
 *	Lock the screen.
 *	Turn on the Chromebook, put it to sleep mode, or wake it up.

\* for selected models

Your Chromebook also supports some key combinations.

alt + 	Go to the previous page.
alt + 	Go to the next page.
ctrl + 	Take a screenshot.
alt + 	Switch the letter case between the upper case and lower case.
l + 	Lock the screen.
ctrl + alt + ?	View all keyboard shortcuts.

To change the keyboard settings:

1. Click the setting icon in the system tray, and then click **Device → Keyboard**.
2. Follow the on-screen instructions to change the settings as you prefer.

## Use the touchpad

The entire touchpad surface is sensitive to finger touch and movement. You can use the touchpad to perform all the pointing, clicking, and scrolling functions of a traditional mouse.

## Use the touch gestures

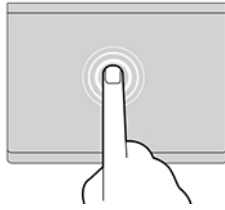

Tap once to select or open an item.

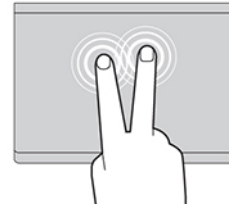

Tap twice quickly to display a shortcut menu.

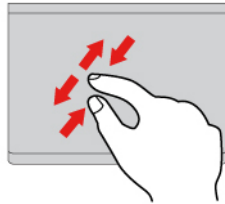

Two-finger zoom in or zoom out.

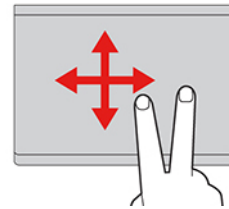

Scroll through items.

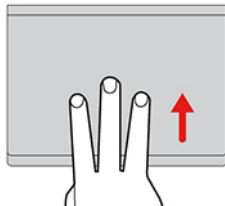

Open the task view.

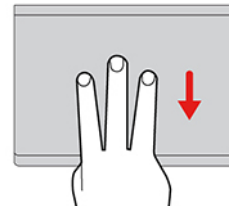

Show the current window.

### Notes:

- When using two or more fingers, ensure that you position your fingers slightly apart.
- Some gestures are only available when you are using certain apps.
- If the touchpad surface is stained with oil, turn off the Chromebook first. Then, gently wipe the touchpad surface with a soft and lint-free cloth moistened with lukewarm water or computer cleaner.

To change the settings:

1. Click the setting icon in the system tray, and then click **Device → Touchpad**.
2. Follow the on-screen instructions to change the settings as you prefer.

If **Enable tap-to-click** is turned on, you can tap or press the touchpad. Otherwise, you can only press the touchpad to achieve the clicking function of a traditional mouse.

## Use the touch screen (for Lenovo 300e/500e Chromebook Gen 3 only)

If your Chromebook display supports the multi-touch function, you can navigate the screen with simple touch gestures.

**Note:** Some gestures might not be available depending on the app you use.



Tap once to single click



Tap and hold to right-click

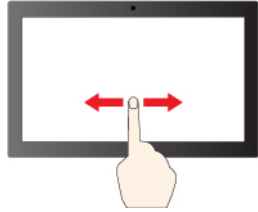

Slide to scroll through items

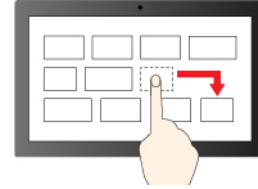

Drag

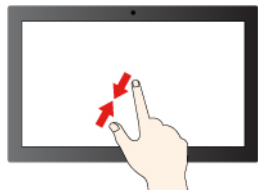

Zoom out

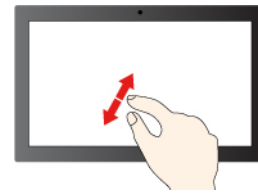

Zoom in

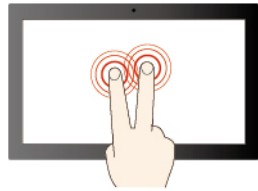

Tap with two fingers to open a shortcut menu

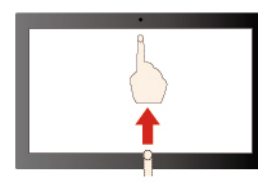

Swipe upwards to unfold the app Launcher

### Maintenance tips:

- Turn off the Chromebook before cleaning the multi-touch screen.
- Use a dry, soft, and lint-free cloth or a piece of absorbent cotton to remove fingerprints or dust from the multi-touch screen. Do not apply solvents to the cloth.
- The multi-touch screen is a glass panel covered with a plastic film. Do not apply pressure or place any metallic object on the screen, which might damage the touch panel or cause it to malfunction.
- Do not use fingernails, gloved fingers, or inanimate objects for input on the screen.
- Regularly calibrate the accuracy of the finger input to avoid a discrepancy.

## Use the electronic pen (for selected models of Lenovo 300e/500e Chromebook Gen 3)

Selected models are shipped with an electronic pen. To use the pen, slide it out of the pen slot. When not in use, put it back into its slot.

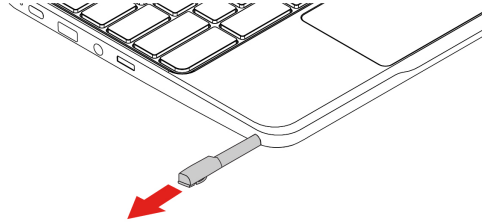

### Notes:

- You might need to install additional apps such as Google Keep for better use of the pen.
- For computer models come with a pen dummy, you can purchase an electronic pen to use. To purchase the pen, go to <https://www.lenovo.com/accessories>. To remove the pen dummy, see “Pen dummy” on page 17.

### Use the electronic pen

You can perform the following operations with the pen:

- To open an app or a Web page, tap the display once.
- To display the shortcut menu or make a selection, tap the display and hold the pen there for one second.

## Get to know your Chromebook modes (for Lenovo 300e/500e Chromebook Gen 3)

Rotate the display to switch among different modes according to your preference. The keyboard is automatically disabled in the stand mode, tent mode, and tablet mode. Use the touch screen to control your Chromebook instead.

**Attention:** Do not rotate the Chromebook display with too much force, or apply too much force to the upper-right or upper-left corner of the Chromebook display. Otherwise, the display or hinges might get damaged.



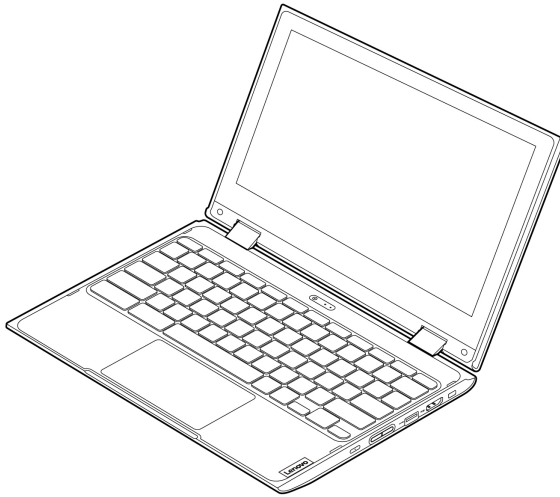

**Laptop mode**

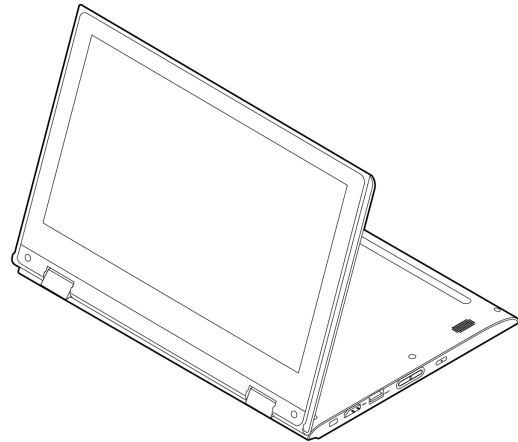

**Stand mode**

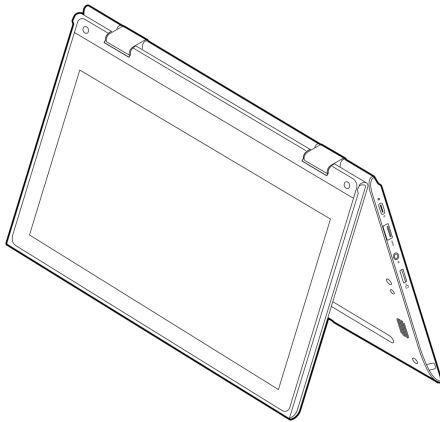

**Tent mode**

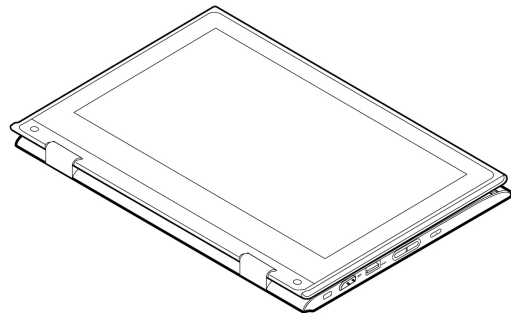

**Tablet mode**

**Warning:** When operating in the tablet mode with any external device connected, the upper case (keyboard's side) of the Chromebook may become hot. Avoid keeping your hands, lap, or any part of the body in contact with the upper case for over one minute.

## **Connect to an external display**

Connect your Chromebook to a projector or a monitor to give presentations or expand your workspace.

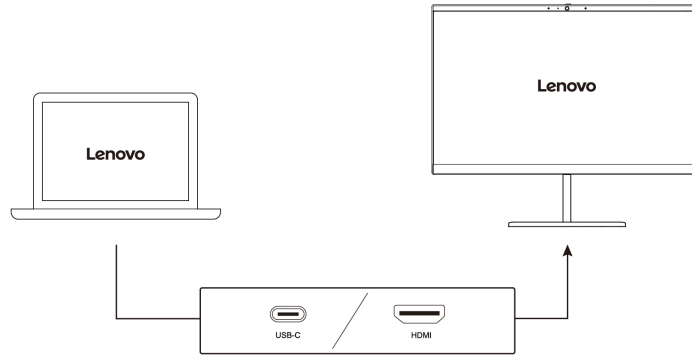

## Supported resolution

The following table lists the supported maximum resolution of the external display.

Table 1. *Lenovo 100e/300e Chromebook Gen 3*

Connect the external display to	Supported resolution
USB-C (3.2 Gen 1) connector	Up to 3840 x 2160 pixels @ 30 Hz
HDMI connector	Up to 3840 x 2160 pixels @ 30 Hz

Table 2. *Lenovo 500e Chromebook Gen 3*

Connect the external display to	Supported resolution
USB-C (3.2 Gen 1) connector	Up to 4096 x 2160 pixels @ 60 Hz
HDMI connector	Up to 4096 x 2160 pixels @ 24 Hz

To change display settings:

1. Click the setting icon in the system tray, and then click **Device → Displays**.
2. Follow the on-screen instructions to change the display settings as you prefer.

## Set the power plan

For ENERGY STAR® compliant Chromebooks, the following power plan takes effect when your Chromebooks have been idle for a specified duration:

Table 3. *Default power plan (when plugged into ac power)*

- Turn off the display: After seven minutes and 30 seconds
- Put the Chromebook into sleep: After eight minutes and 30 seconds

To reset the power plan to achieve the best balance between performance and power saving:

1. Click the setting icon in the system tray, and then click **Device → Power**.
2. Follow the on-screen instructions to change the settings as you prefer.

## Shut down your Chromebook

When you finish working with your Chromebook, shut it down to save power.

- Click  in the system tray.
- Press the power button.



---

## Chapter 3. CRU replacement

Customer Replaceable Units (CRUs) are parts that can be upgraded or replaced by the customer. The computers contain the following types of CRUs:

- **Self-service CRUs:** Refer to parts that can be installed or replaced easily by customer themselves or by trained service technicians at an additional cost.
- **Optional-service CRUs:** Refer to parts that can be installed or replaced by customers with a greater skill level. Trained service technicians can also provide service to install or replace the parts under the type of warranty designated for the customer's machine.

If you intend on installing a CRU, Lenovo will ship the CRU to you. CRU information and replacement instructions are shipped with your product and are available from Lenovo at any time upon request. You might be required to return the defective part that is replaced by the CRU. When return is required: (1) return instructions, a prepaid shipping label, and a container will be included with the replacement CRU; and (2) you might be charged for the replacement CRU if Lenovo does not receive the defective CRU within thirty (30) days of your receipt of the replacement CRU. For full details, see the Lenovo Limited Warranty documentation at [https://www.lenovo.com/warranty/llw\\_02](https://www.lenovo.com/warranty/llw_02).

---

### What are CRUs

Refer to the following CRU list for your Chromebook.

#### Self-service CRUs

- ac power adapter
- Pen dummy\*
- Electronic pen\*
- Nano-SIM-card tray\*
- Power cord

#### Optional-service CRUs

- Base cover assembly

\* for selected models

**Note:** Replacement of any parts not listed above, including the built-in rechargeable battery, must be done by a Lenovo-authorized repair facility or technician. Go to <https://support.lenovo.com/partnerlocation> for more information.

---

### Replace a CRU

Follow the replacement procedure to replace a CRU.

#### Pen dummy

##### Prerequisite

Before you start, read [Generic Safety and Compliance Notices](#) and print the following instructions.

For access, do the following:

1. Ensure that your computer is off or in sleep mode. Disconnect the computer from ac power and all connected cables.
2. Close the computer display and turn the computer over.

### Removal procedure

Use a tool as shown to release the pen dummy, then remove it.

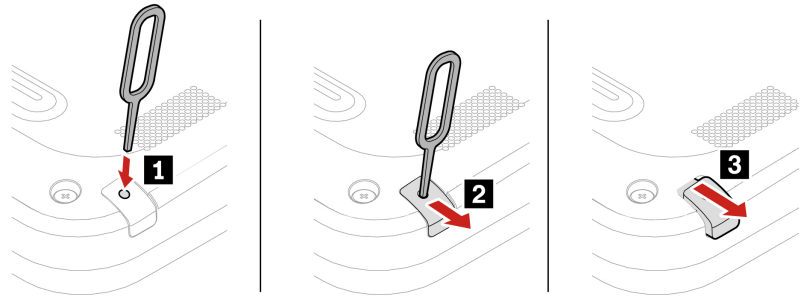

## Base cover assembly

### Prerequisite

Before you start, read [Generic Safety and Compliance Notices](#) and print the following instructions.

**Note:** Do not remove the base cover assembly when your Chromebook is connected to ac power.

For access, do the following:

1. Disable the built-in battery. Press  together with the power button for about five seconds, and at the same time detach the ac power adapter from the Chromebook.

**Note:** Power supply from the built-in battery will resume after you reconnect the Chromebook to the ac power adapter.

2. Close the Chromebook display and turn over the Chromebook.

### Removal procedure

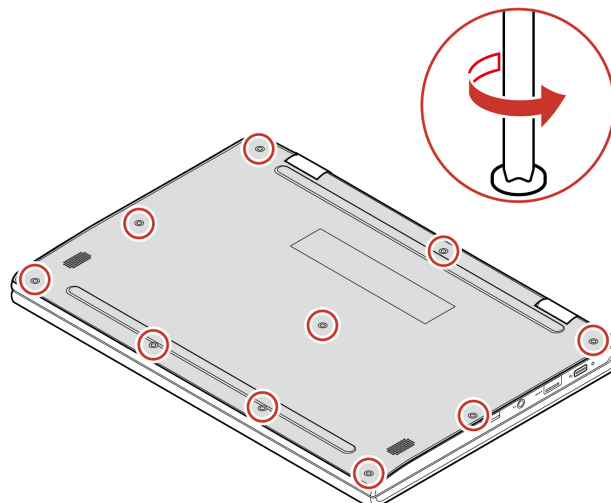

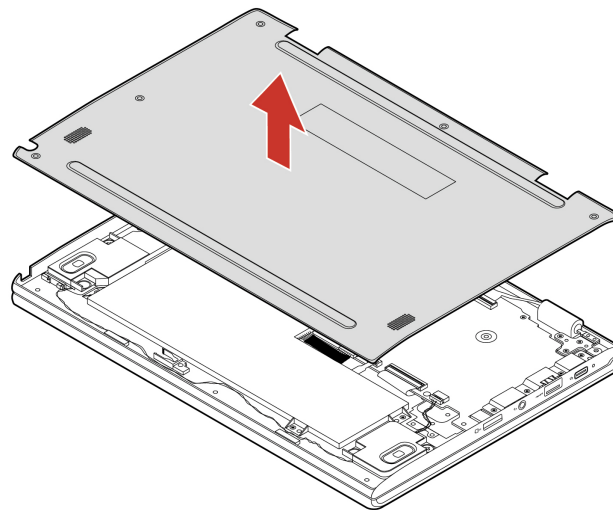
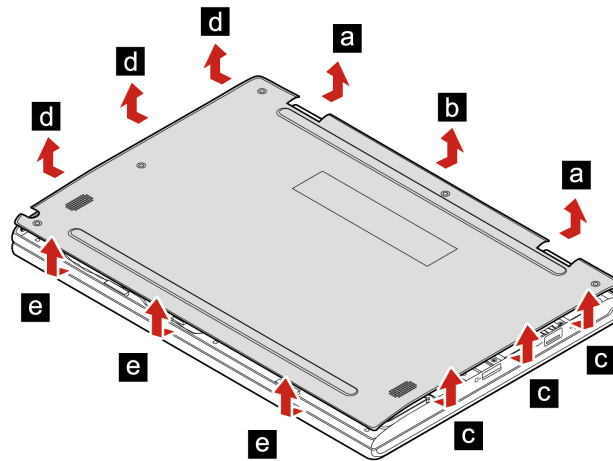

## Installation procedure

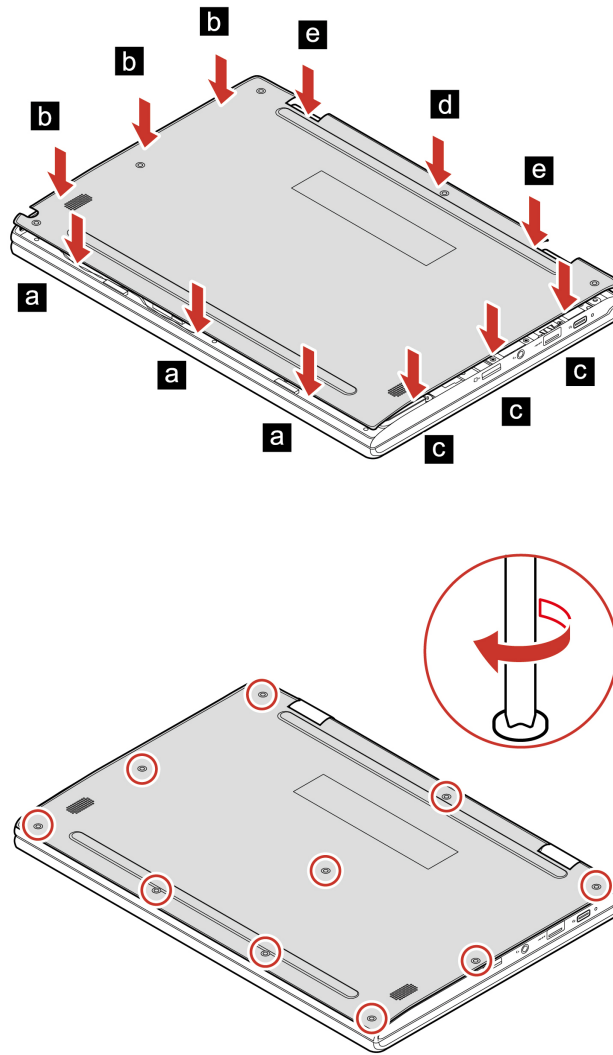

## Troubleshooting

If the Chromebook does not start up after you reinstall the base cover assembly, disconnect the ac power adapter and then reconnect it to the Chromebook.



---

## Chapter 4. Help and support

---

### Frequently asked questions

---

What do I do if my Chromebook stops responding?

1. Press and hold the power button until the Chromebook turns off. Then, restart the Chromebook.
2. If step 1 does not work:
  - For models with an emergency reset hole: Insert a straightened paper clip into the emergency reset hole to cut off power supply temporarily. Then, restart the Chromebook with ac power connected.
  - For models without an emergency reset hole:
    - For models with the removable battery, remove the removable battery and disconnect all power sources. Then, reconnect to ac power and restart the Chromebook.
    - For models with the built-in battery, disconnect all power sources. Press and hold the power button for about seven seconds. Then, reconnect to ac power and restart the Chromebook.

---

What do I do if I spill liquid on the Chromebook?

1. Carefully unplug the ac power adapter and turn off the Chromebook immediately. The more quickly you stop the current from passing through the Chromebook the more likely you will reduce damage from short circuits.  
**Attention:** Although you might lose some data or work by turning off the Chromebook immediately, leaving the Chromebook on might make your Chromebook unusable.
2. Do not try to drain out the liquid by turning over the Chromebook. If your Chromebook has keyboard drainage holes on the bottom, the liquid will be drained out through the holes.
3. Wait until you are certain that all the liquid is dry before turning on your Chromebook.

---

How do I disinfect my Chromebook?

1. Squeeze out excess liquid from wipe or disinfecting cloth before using. Recommended wipes are hydrogen peroxide wipes and alcohol based wipes. Do not use wipes containing sodium hypochlorite (bleach).
  2. Gently wipe the Chromebook thoroughly, being careful to ensure no liquid drips into the Chromebook. Do not wipe on connector pins.
  3. After disinfecting, follow the cleaning procedure from the wipe supplier to minimize chemical buildup of disinfectant residue.
  4. Always allow the Chromebook to completely dry prior to any use.
- For more information about cleaning and disinfecting, go to <https://support.lenovo.com/in/en/solutions/ht035676>.

---

## Call Lenovo

If you have tried to correct the problem yourself and still need help, you can call Lenovo Customer Support Center.

## Before you contact Lenovo

Prepare the following before you contact Lenovo:

1. Record the problem symptoms and details:

- What is the problem? Is it continuous or intermittent?
- Any error message or error code?
- What operating system are you using? Which version?
- Which software applications were running at the time of the problem?
- Can the problem be reproduced? If so, how?

2. Record the system information:

- Product name
- Machine type and serial number

The following illustration shows where to find the machine type and serial number of your Chromebook.

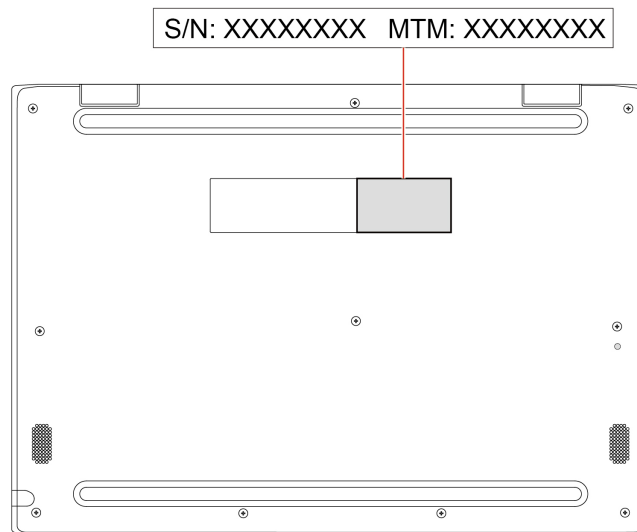

## Lenovo Customer Support Center

During the warranty period, you can call Lenovo Customer Support Center for help.

### Telephone numbers

For a list of the Lenovo Support phone numbers for your country or region, go to <https://pcsupport.lenovo.com/supportphonenumber> for the latest phone numbers.

**Note:** Phone numbers are subject to change without notice. If the number for your country or region is not provided, contact your Lenovo reseller or Lenovo marketing representative.

### Services available during the warranty period

- Problem determination - Trained personnel are available to assist you with determining if you have a hardware problem and deciding what action is necessary to fix the problem.
- Lenovo hardware repair - If the problem is determined to be caused by Lenovo hardware under warranty, trained service personnel are available to provide the applicable level of service.
- Engineering change management - Occasionally, there might be changes that are required after a product has been sold. Lenovo or your reseller, if authorized by Lenovo, will make selected Engineering Changes (ECs) that apply to your hardware available.

## Services not covered

- Replacement or use of parts not manufactured for or by Lenovo or nonwarranted parts
- Identification of software problem sources
- Configuration of UEFI BIOS as part of an installation or upgrade
- Changes, modifications, or upgrades to device drivers
- Installation and maintenance of network operating systems (NOS)
- Installation and maintenance of programs

For the terms and conditions of the Lenovo Limited Warranty that apply to your Lenovo hardware product, go to:

- [https://www.lenovo.com/warranty/llw\\_02](https://www.lenovo.com/warranty/llw_02)
- <https://pcsupport.lenovo.com/warrantylookup>

---

## Get help from Google

After signing in to your Chromebook, start Get Help from the app Launcher. The Get Help app provides comprehensive instructions on using your Chromebook.

In addition, if you are interested in visiting the Chromebook Help Center and Community, go to <http://google.com/support/chromebook>.



---

## Appendix A. Compliance information

For more compliance information, refer to *Regulatory Notice* at <https://pcsupport.lenovo.com> and *Generic Safety and Compliance Notices* at [https://pcsupport.lenovo.com/docs/generic\\_notices](https://pcsupport.lenovo.com/docs/generic_notices).

---

### Locate the wireless antennas

Your computer has a wireless antenna system. You can enable wireless communication wherever you are. The following illustrations show the antenna locations on your computer.

**For models with wireless-LAN card only**



- 1 Wireless-LAN antenna (auxiliary)
- 2 Wireless-LAN antenna (main)

## For models with wireless-LAN and wireless-WAN cards

Lenovo 100e Chromebook Gen 3



- 1 Wireless-WAN antenna (auxiliary)
- 2 Wireless-WAN antenna (main)
- 3 Wireless-LAN antenna (auxiliary)
- 4 Wireless-LAN antenna (main)

Lenovo 300e/500e Chromebook Gen 3



- 1 Wireless-WAN antenna (auxiliary)
- 2 Wireless-LAN antenna (auxiliary)
- 3 Wireless-LAN antenna (main)
- 4 Wireless-WAN antenna (main)

**Certification-related information**

Product name	Machine types
Lenovo 100e Chromebook Gen 3	82J7 and 82J8
Lenovo 300e Chromebook Gen 3	82J9 and 82JA
<ul style="list-style-type: none"> <li>• Lenovo 500e Chromebook Gen 3</li> <li>• (82JB)Lenovo 500e Chromebook Gen 3*</li> <li>• (82JC)Lenovo 500e Chromebook Gen 3*</li> </ul>	82JB and 82JC

\* for India only

The latest compliance information is available at:

---

## Federal Communications Commission (FCC) Supplier's Declaration of Conformity

The following information refers to the following products:

Product name	Machine type
Lenovo 100e Chromebook Gen 3	82J7 and 82J8
Lenovo 300e Chromebook Gen 3	82J9 and 82JA
Lenovo 500e Chromebook Gen 3	82JB and 82JC

This equipment has been tested and found to comply with the limits for a Class B digital device, pursuant to Part 15 of the FCC Rules. These limits are designed to provide reasonable protection against harmful interference in a residential installation. This equipment generates, uses, and can radiate radio frequency energy and, if not installed and used in accordance with the instructions, may cause harmful interference to radio communications. However, there is no guarantee that interference will not occur in a particular installation. If this equipment does cause harmful interference to radio or television reception, which can be determined by turning the equipment off and on, the user is encouraged to try to correct the interference by one or more of the following measures:

- Reorient or relocate the receiving antenna.
- Increase the separation between the equipment and receiver.
- Connect the equipment into an outlet on a circuit different from that to which the receiver is connected.
- Consult an authorized dealer or service representative for help.

Lenovo is not responsible for any radio or television interference caused by using other than recommended cables and connectors or by unauthorized changes or modifications to this equipment. Unauthorized changes or modifications could void the user's authority to operate the equipment.

This device complies with Part 15 of the FCC Rules. Operation is subject to the following two conditions: (1) this device may not cause harmful interference, and (2) this device must accept any interference received, including interference that may cause undesired operation.

Responsible Party:  
Lenovo (United States) Incorporated  
7001 Development Drive  
Morrisville, NC 27560  
Email: [FCC@lenovo.com](mailto:FCC@lenovo.com)



---

### Location for the FCC ID and IC ID

If you purchased your computer in the United States or Canada and the computer includes factory-preinstalled wireless modules, a piece of text containing identification strings for these modules (FCC ID and IC ID) is visible on the computer's bottom cover. The text may either be laser etched on the bottom cover or on a physical label affixed to it. To obtain the FCC ID or IC ID for the factory-preinstalled wireless module, check the bottom cover for strings directly after "FCC ID" or "IC ID".



---

## Safety instructions for teachers, parents and adult supervisors

This Chromebook is intended for use as a child development tool primarily by children, 6 years of age or above. There must be supervision by an adult. It is a must to have a thorough explanation to children on safe and proper handling of the computer, battery pack, and ac power adapter.

- For ITE with power supplies not intended to be handled by children: As with all electrical products, precautions should be observed handling and use to prevent electric shock. The ac power adapter should not be handled by children.
- The computer should not be placed on the bare skin (lap) of the child for long periods. The computer should be placed on a flat surface, like desktop, if your child intends to use it for more than a few minutes.
- The computer (including the ac power adapter and the battery pack, as applicable) should not be left in the rain or subjected to exposure to water. If cleaning is necessary do not immerse it in water; wipe clean with damp cloth.
- The computer (including the ac power adapter and the battery pack, as applicable) should not be dropped, crushed (stepped on) or otherwise abused.
- An adult should caution his or her child about the potential trip hazard as posed by the cable between a power source and the computer. An adult should inspect the computer (including the ac power adapter and the battery pack, as applicable) periodically for damage. Similarly, if a child notices damaged/broken parts, this should be reported to the teacher/parents/adult supervisors immediately. Damaged parts may be replaced through service provided by Lenovo.



**ELECTRICALLY OPERATED PRODUCT. Not recommended for children under 3 years of age (or other intended age range). As with all electrical products, precautions should be observed during handling and use of electrical products to reduce the risk of electric shock.**

---

## Operating environment

### Maximum altitude (without pressurization)

3048 m (10 000 ft)

### Temperature

- Operating: 5°C to 35°C (41°F to 95°F)
- Storage: 5°C to 43°C (41°F to 109°F)

**Note:** When you charge the battery, its temperature must be no lower than 10°C (50°F).

### Relative humidity

- Operating: 8% to 95% at wet-bulb temperature 23°C (73°F)
- Storage: 5% to 95% at wet-bulb temperature 27°C (81°F)



---

## Appendix B. Open source information

Your Chromebook may include software made publicly available by Google and other third parties, including software licensed under the General Public License and/or the Lesser General Public License (the “open source software”).

You may obtain a copy of the corresponding source code for any such open source software licensed under the General Public License and/or the Lesser General Public License (or any other license requiring us to make a written offer to provide corresponding source code to you) from Lenovo for a period of three years without charge except for the cost of media, shipping, and handling, upon written request to Lenovo. This offer is valid to anyone in receipt of this device. You may send your request in writing to the address below accompanied by a check or money order for \$5 to:

*Lenovo Legal Department  
Attn: Open Source Team / Source Code Requests  
8001 Development Dr.  
Morrisville, NC 27560*

As part of your request, please include a “UNAME” and a “CHROME VERSION” of this device available by typing: “Chrome://system” in a Chrome Browser’s address bar. Be sure to provide a return address.

The open source software is distributed in hope it will be useful, but WITHOUT ANY WARRANTY; without even the implied warranty of MERCHANTABILITY or FITNESS FOR A PARTICULAR PURPOSE. See for example the GNU General Public License and/or the Lesser General Public License for more information.

To view additional information regarding licenses, acknowledgments and required copyright notices for the open source software used in your device, type: “Chrome://credits” in the Chrome Browser’s address bar.

This device may include certain pre-installed application programs or pre-configured links for downloading application programs published by parties other than Lenovo. Such third-party application programs may include open source software made publicly available by the respective publishers of those application programs. You may obtain the corresponding source code for any such open source software directly from the publisher of the applicable application program, to the extent permitted under the relevant open source software license agreement. Additional information is provided by the publisher of each application program within the menu structure of its application program.



---

## Appendix C. Notices and trademarks

### Notices

Lenovo may not offer the products, services, or features discussed in this document in all countries. Consult your local Lenovo representative for information on the products and services currently available in your area. Any reference to a Lenovo product, program, or service is not intended to state or imply that only that Lenovo product, program, or service may be used. Any functionally equivalent product, program, or service that does not infringe any Lenovo intellectual property right may be used instead. However, it is the user's responsibility to evaluate and verify the operation of any other product, program, or service.

Lenovo may have patents or pending patent programs covering subject matter described in this document. The furnishing of this document does not give you any license to these patents. You can send license inquiries, in writing, to:

*Lenovo (United States), Inc.  
8001 Development Drive  
Morrisville, NC 27560  
U.S.A.  
Attention: Lenovo Director of Licensing*

LENOVO PROVIDES THIS PUBLICATION "AS IS" WITHOUT WARRANTY OF ANY KIND, EITHER EXPRESS OR IMPLIED, INCLUDING, BUT NOT LIMITED TO, THE IMPLIED WARRANTIES OF NON-INFRINGEMENT, MERCHANTABILITY OR FITNESS FOR A PARTICULAR PURPOSE. Some jurisdictions do not allow disclaimer of express or implied warranties in certain transactions, therefore, this statement may not apply to you.

Changes are made periodically to the information herein; these changes will be incorporated in new editions of the publication. To provide better service, Lenovo reserves the right to improve and/or modify the products and software programs described in the manuals included with your computer, and the content of the manual, at any time without additional notice.

The software interface and function and hardware configuration described in the manuals included with your computer might not match exactly the actual configuration of the computer that you purchase. For the configuration of the product, refer to the related contract (if any) or product packing list, or consult the distributor for the product sales. Lenovo may use or distribute any of the information you supply in any way it believes appropriate without incurring any obligation to you.

The products described in this document are not intended for use in implantation or other life support applications where malfunction may result in injury or death to persons. The information contained in this document does not affect or change Lenovo product specifications or warranties. Nothing in this document shall operate as an express or implied license or indemnity under the intellectual property rights of Lenovo or third parties. All information contained in this document was obtained in specific environments and is presented as an illustration. The result obtained in other operating environments may vary.

Lenovo may use or distribute any of the information you supply in any way it believes appropriate without incurring any obligation to you.

Any references in this publication to non-Lenovo Web sites are provided for convenience only and do not in any manner serve as an endorsement of those Web sites. The materials at those Web sites are not part of the materials for this Lenovo product, and use of those Web sites is at your own risk.

Any performance data contained herein was determined in a controlled environment. Therefore, the result obtained in other operating environments may vary significantly. Some measurements may have been made on development-level systems and there is no guarantee that these measurements will be the same on generally available systems. Furthermore, some measurements may have been estimated through extrapolation. Actual results may vary. Users of this document should verify the applicable data for their specific environment.

This document is copyrighted by Lenovo and is not covered by any open source license, including any Linux® agreement(s) which may accompany software included with this product. Lenovo may update this document at any time without notice.

For the latest information or any questions or comments, contact or visit the Lenovo Web site:

<https://pcsupport.lenovo.com>

### **Trademarks**

LENOVO and LENOVO logo are trademarks of Lenovo. ENERGY STAR is a registered trademark of the U.S. Environmental Protection Agency. Google, Google Keep, and Chromebook are trademarks or registered trademarks of Google LLC. NanoSaver and Cleat are trademarks or registered trademarks of ACCO Brands. USB-C® is a registered trademark of USB Implementers Forum. Wi-Fi is a registered trademark of Wi-Fi Alliance. All other trademarks are the property of their respective owners.



**Lenovo**