



i n v e n t

User's Guide

HP iPAQ Pocket PC h6300 Series

Document Part Number: 353283-001

June 2004

© 2004 Hewlett-Packard Development Company, L.P.

iPAQ is a trademark of Hewlett-Packard Development Company, L.P. in the U.S. and other countries.

Microsoft, Windows, the Windows logo, Outlook, and ActiveSync are trademarks of Microsoft Corporation in the U.S. and other countries.

HP iPAQ Pocket PC h6300 Series is Powered by Microsoft® Windows® Mobile™ 2003 Software for Pocket PC.



SD Logo is a trademark of Secure Digital.

Bluetooth is a trademark owned by its proprietor and used by Hewlett-Packard Company under license.

Hewlett-Packard Company shall not be liable for technical or editorial errors or omissions contained herein or for incidental or consequential damages in connection with the furnishing, performance, or use of this material. The information in this document is provided “as is” without warranty of any kind, including, but not limited to, the implied warranties of merchantability and fitness for a particular purpose, and is subject to change without notice. The warranties for HP products are set forth in the express limited warranty statements accompanying such products. Nothing herein should be construed as constituting an additional warranty.

This document contains proprietary information that is protected by copyright. No part of this document may be photocopied, reproduced, or translated to another language without the prior written consent of Hewlett-Packard Company.



WARNING: Text set off in this manner indicates that failure to follow directions could result in bodily harm or loss of life.



CAUTION: Text set off in this manner indicates that failure to follow directions could result in damage to equipment or loss of information.

User's Guide
HP iPAQ Pocket PC h6300 Series
First Edition (June 2004)
Document Part Number: 353283-001

Contents

1 Getting to Know Your HP iPAQ Pocket PC

Using the Stylus	1-4
Setting the Date and Time	1-5
Setting the Time for Home and Locations You Are Visiting	1-6
Setting the Date	1-6
Entering Owner Information	1-7
Setting a Password.	1-7
Resetting the Unit.	1-9
Performing a Soft Reset.	1-9
Performing a Hard Reset	1-10
Aligning the Screen	1-11
Status Icons	1-12
Routine Care.	1-14
Traveling with Your Pocket PC.	1-15

2 Learning the Basics

Using the Today Screen	2-1
Navigation Bar.	2-2
Command Bar	2-2
Pop-Up Menus.	2-3
Creating information	2-3
Customizing the Today Screen	2-4
Customizing the Application Buttons	2-5
Locking the Application Buttons.	2-6

Using Applications	2–6
Opening Applications	2–6
Minimizing Applications	2–7
Closing Applications	2–7
Installing Applications	2–7
Backing Up Information	2–8
Using iPAQ File Store Folder	2–9

3 Learning Input Methods

Using Input Software	3–1
Changing Word Suggestion Options	3–1
Using the On-Screen Keyboard	3–3
Writing with the Stylus and the Letter Recognizer	3–4
Writing with the Stylus and Microsoft Transcriber	3–5
Writing with the Stylus and Block Recognizer	3–6
Drawing and Writing on the Screen	3–7
Using the Removable Thumb Keyboard	3–9
Keyboard Components	3–10
Keyboard Connectors	3–11
Connecting the Keyboard to Your iPAQ Pocket PC	3–12
Checking the Keyboard Connection	3–13
Disconnecting the Keyboard	3–13
Configuring the Keyboard	3–13
Using the Function and Shortcut Keys	3–14
“Sticky” Keys	3–15
Special Keys	3–15
Accent Characters	3–15
Disabling the Thumb Keyboard	3–18

4 Using the Phone Features

SIM Card	4–1
Inserting a SIM Card	4–2
Activating Your Phone Service	4–3

Phone Features	4-3
Your PIN	4-4
Phone Buttons and Icons	4-5
Checking Your Connection and Signal Strength	4-7
Selecting a Frequency Band	4-7
Turning the Phone On and Off	4-8
HP Profiles	4-9
Setting a Profile	4-10
Switching a Profile	4-11
Making and Receiving Phone Calls	4-12
Making a Call	4-12
Answering a Call	4-12
Ending a Call	4-13
Making a Call from Contacts	4-13
Making a Call Using Speed Dial	4-14
Making a Call from Call History	4-15
Making a Conference Call	4-15
Adjusting Phone Volume	4-15
Enabling the Mute Function	4-15
Setting Ring Tones	4-16
Enabling Speakerphone Mode	4-17
Taking Notes During a Call	4-17
Using Voice Mail	4-17
Putting a Call on Hold	4-18
Using Call Waiting	4-18
Displaying Caller ID	4-18
Blocking Calls	4-19
Forwarding Calls	4-19
Change the System Volume	4-20
Change the Ringer Volume	4-20
Changing the Phone Settings	4-21
Changing Services Settings	4-21
Viewing Available GSM/GPRS Networks	4-22
Changing Network Settings	4-22
Manually Selecting a Network	4-23
Configuring Your Pocket PC for Your SIM Card	4-23

Modifying the GPRS Network Settings 4-24
TTY Functionality for the Hearing-Impaired 4-33

5 Managing Multiple Wireless Connections

Using the iPAQ Wireless Manager 5-1
 Power Buttons 5-2
 Settings Buttons 5-3
 Managing Data Connections 5-4

6 Making Your Data Connections

Impact of Data Connection When
Phone Call is Received. 6-2
Using GSM/GPRS Connections 6-2
 Creating a GPRS Connection 6-3
 Creating a GSM Connection 6-4
 Switching Between GPRS and Wi-Fi 6-5
 Switching Between Wi-Fi Access Points 6-6
Setting Up a WAP Browser 6-6
 Viewing WAP Pages 6-7
Connecting to a Private Network 6-7
 Setting Up VPN Server Connections 6-7
 Setting Up Proxy Server Settings 6-8
Managing Your E-mail 6-8
Entering an Internet Address 6-9
Using a Favorites List 6-9

7 Using Wi-Fi

Getting Acquainted 7-1
Learning the Terms 7-2
Getting Started with Wi-Fi 7-4
 Powering Wi-Fi On or Off 7-4
 Automatically Connecting to a Network 7-5
 Manually Entering New Network Settings 7-5
 Searching for Networks to Access 7-7

Connecting to Hotspots	7–8
Viewing or Editing a Wireless Network	7–9
Deleting a Wireless Network	7–10
Monitoring Signal Status and Strength	7–11
Wi-Fi Signal Status	7–11
Wi-Fi Signal Strength	7–11
Working with Network Settings	7–12
Looking Up an IP Address	7–12
Changing TCP/IP Settings	7–13
Changing DNS and WINS Settings	7–14
Setting Up VPN Server Connections	7–15
Changing VPN Server Connections	7–16
Starting VPN Server Connections	7–17
Setting Up Proxy Server Settings	7–18
WLAN Security Protocol Utilities	7–18
TTLS	7–19
802.1X Certificate Enroller	7–19
LEAP Registration Utility	7–20

8 Using Bluetooth

Getting Acquainted with Bluetooth	8–2
Understanding Terms	8–3
Supported Services	8–4
Working with Bluetooth Settings	8–4
Turning On Bluetooth	8–5
Opening Bluetooth Settings	8–5
Setting Accessibility Properties	8–5
Enabling Bluetooth Services	8–6
Setting a Shared Folder	8–8
Understanding Profiles	8–9
Working with Bluetooth Manager	8–12
Opening Bluetooth Manager	8–12
Locating and Selecting a Device	8–12
Connecting to Other Devices	8–14
Identifying the Communications Port	8–14

Establishing a Headset Connection	8–14
Establishing an ActiveSync Connection	8–15
Establishing a Serial Connection	8–19
Dial-Up Networking Service	8–20
Using Dial-Up Networking Service	8–20
Joining a Personal Area Network	8–21
Working with Files	8–21
Creating a File Transfer Connection	8–22
Sending Files	8–22
Creating a Folder on a Remote Device	8–22
Receiving a File from a Remote Device	8–22
Deleting a File from a Remote Device	8–23
Using Business Card Exchange	8–23
Setting Up Your Business Card Information	8–23
Opening a Connection	8–26
Viewing Connection Status	8–26
Closing a Connection	8–27
Viewing Connection Information	8–27
Working with Connections	8–27

9 Using the Camera Features

Camera Components	9–2
Taking a Picture	9–2
Ending Your Photo Session	9–4
Adjusting the Camera Settings	9–5
White Balance	9–5
Color	9–6
Compression	9–6
Resolution	9–6
Exposure Mode	9–7
Setting Up Other Features	9–7
Camera Sounds	9–7
Configuring Instant Review	9–7
Using the Self-Timer	9–8
Configuring File Settings	9–8

Using HP Image Zone	9–9
Viewing Pictures	9–9
Viewing a Picture Full-Screen.	9–10
Recording Sound With a Picture	9–10
Viewing a Slideshow	9–10
E-mailing a Picture.	9–12
Exiting HP Image Zone	9–12
Tips for Taking Better Pictures	9–12

10 Expansion Cards

Installing a Secure Digital (SD) Expansion Card	10–2
Removing a Secure Digital (SD) Expansion Card.	10–3
Viewing the Content of Memory Cards.	10–3

11 Using Inbox and Messaging

Using Inbox	11–1
Synchronizing Inbox	11–2
Using Folders.	11–3
Setting Up an Account.	11–4
E-mail Setup	11–5
Downloading Messages.	11–7
Compose and Send a Message.	11–8
Reply to or Forward a Message.	11–8
Receive Attachments	11–9
Receive Meeting Requests.	11–10
Using Messaging	11–11
Short Message Service (SMS).	11–11
Multimedia Messaging Service (MMS)	11–13

12 Using ActiveSync

Connecting to a Computer	12–2
Installing ActiveSync	12–2
Synchronizing with Your Computer	12–3
Changing Synchronization Settings.	12–5

Copying Files	12-6
Installing Programs	12-7
Backing up and Restoring	12-7
Synchronizing Links	12-7
Using ActiveSync to Send and Receive E-mail.	12-8
Requesting Meetings	12-8

13 Managing the Battery

Installing the Battery	13-2
Removing the Battery	13-3
Charging the Battery	13-4
Charging with the AC Adapter	13-5
Charging with the Synchronization Cradle and AC Adapter	13-7
Charging Over a USB Connection	13-8
Charging a Spare Battery.	13-9
Changing the Backlight Settings.	13-10
Disabling the Application Buttons	13-11
Manually Monitoring the Battery	13-11

14 Troubleshooting

Self-Test Diagnostics.	14-1
Common Problems.	14-2
ActiveSync	14-7
Phone	14-9
Expansion Cards.	14-11
Bluetooth	14-12
Wireless Fidelity	14-13

A Regulatory Notices

Federal Communications Commission Notice	A-1
Declaration of Conformity for products marked with the FCC logo—United States only	A-2
Canadian Notice	A-3
Avis Canadien	A-3
Japanese Notice	A-3
Korean Notice	A-3
European Union Notice	A-4
Declaration of Conformity	A-4
Notice for Use in France and Italy	A-5
Battery Warning	A-6
Taiwan Battery Recycling Notice	A-6
Equipment Warning	A-7
Airline Travel Notice	A-7
Medical Electronic Equipment	A-7
Wireless Notices	A-8
U.S. Regulatory Wireless Notice	A-8
Health and Safety Information—FCC	A-8
Canadian Regulatory Wireless Notice	A-9
Australian Wireless Notice	A-9
Japanese Regulatory Wireless Notice	A-10
Brazilian Regulatory Wireless Notice	A-10
Singaporean Wireless Notice	A-11
Taiwanese Wireless Notice	A-12

B Specifications

System Specifications	B-1
Physical Specifications	B-3
Operating Environment	B-4

Index

Getting to Know Your HP iPAQ Pocket PC

Use this chapter to find out about setting up your Pocket PC and to learn about how it works.

The software programs described below are preinstalled on your Pocket PC or included on the Companion CD. These preinstalled programs are not deleted if your Pocket PC loses power.

You can find detailed information for using these programs in the Help files on your HP iPAQ Pocket PC. To access these Help files, from the **Start** menu, tap **Help** and select a program.

In addition, Microsoft Pocket PC Basics provides instructions on operating the Pocket PC. To locate Pocket PC Basics, go to the **Today** screen and tap **Start > Help > Pocket PC Basics**.

HP iPAQ Software	Functions
HP Asset Viewer	Lists detailed information about your system and its configuration. From the Start menu, tap Settings > System tab > HP Asset Viewer .
HP Image Capture	Take digital photographs and modify settings with your iPAQ Pocket PC Camera.
HP Image Transfer	Transfer digital photographs from the Pocket PC to your personal computer. This software is included on the Companion CD.
HP Image Zone	Display individual images and run slideshows on your Pocket PC. Also print, send, record and email images from your Pocket PC.

HP iPAQ Software	Functions (Continued)
iPAQ Backup	Back up your data to protect it from loss due to a drained battery, accidental deletion, or hardware failure.
iPAQ Wireless	Provides a centralized control to all wireless features on your Pocket PC. It allows you to turn all wireless features on and off and configure settings for phone and data functions using GSM/GPRS, Wi-Fi, and Bluetooth.
Self-Test	Run a basic diagnostic test on the device.

Microsoft Pocket PC Software	Functions
ActiveSync	Synchronize information between your Pocket PC and personal computer so you have the latest information in both locations. Be sure you install ActiveSync on your personal computer before connecting the cradle and Pocket PC to your computer.
Calculator	Perform calculations.
Calendar	Schedule appointments, meetings, and other events, and set an alarm to remind you of the appointments. Appointments for the day are displayed on the Today screen.
Connections	Connect your Pocket PC to the Internet and intranet to browse Web sites, send and receive e-mail, and synchronize information using ActiveSync.
Contacts	Keep an updated list of friends and colleagues to e-mail, message, and telephone.
Inbox	Receive and send Internet e-mail, SMS and MMS messages in Inbox on your Pocket PC or from your computer if ActiveSync is installed. You must have an e-mail address provided by your Internet Service Provider (ISP) or employer to send and receive e-mail.
Notes	Create handwritten or typed notes, drawings, and recordings.
Pocket Excel	Create and edit workbooks or view and edit Excel workbooks created on your computer.
Pocket Internet Explorer	Browse the Internet and download pages through synchronization or by connecting to the Internet.

Microsoft Pocket PC Software	Functions (Continued)
Pocket Word	Create new documents or view and edit Word documents created on your computer.
Ring Tones	Select different sounds to notify you of incoming calls.
Settings	Obtain quick access to settings for the backlight, clock, memory, power, regional settings, Today screen, password, sounds and notifications, etc.
Tasks	Keep track of your to-do list.
Terminal Services Client	Log onto your computer and use all the programs available on that computer from your Pocket PC (Windows 2000 and XP or later).
Windows Media Player 9 Series	Play digital audio and video files in Windows Media or MP3 format on your device.

Using the Stylus

Your Pocket PC comes with a stylus that you should use to tap or write on your screen.

NOTE: Use the stylus to tap and write on the screen, and use your fingers to press the Power button, application buttons on the bottom of the device, and the camera's on-screen shutter button.



CAUTION: To prevent damage to your Pocket PC screen, never use any device other than the stylus that comes with the Pocket PC or an approved replacement to tap or write on the screen. If you lose or break your stylus, you can order extras at www.hp.com/Go/iPAQaccessories.

You can perform three basic actions using the stylus:

Tap—Lightly touch the screen to select or open an item. Lift the stylus after you tap an item. Tapping is equivalent to clicking an item with the mouse on your computer.

Drag—Place the point of the stylus on the screen and drag an item across the screen without lifting the stylus until you have completed the selection. Dragging is equivalent to dragging with the left mouse button pressed on your computer.

Tap and hold—Hold the stylus pointer on an item for a short time until a menu displays. Tapping and holding is equivalent to right-clicking your computer mouse button. When you tap and hold, a circle of blue dots appears around the stylus to indicate that the menu will soon pop up.

Setting the Date and Time

When you turn on your Pocket PC for the first time, you are requested to select your time zone. After setting the time zone, you still need to set the time and date on your unit. Tap the **Clock** icon on the Today screen to set the time and date. All three settings are located in the Clock Settings screen and can be set at the same time.

NOTE: By default, the time on the Pocket PC is synchronized with your computer each time the two devices connect using ActiveSync.

Setting the Time for Home and Locations You Are Visiting

From the **Start** menu, tap **Settings** > **System** tab > **Clock** icon.

Shortcut: From the **Today** screen, tap the **Clock** icon to set the time.

1. Tap either **Home** or **Visiting**.
2. Tap the **time-zone** down arrow, and select the appropriate time zone.
3. Tap the hour, minutes, or seconds, and use the up and down arrows to adjust the time.

Shortcut: You can also adjust the time by moving the hands of the clock with the stylus.

4. Tap **AM** or **PM**.
5. Tap **OK**.
6. Tap **Yes** to save the time.

Setting the Date

1. From the **Start** menu, tap **Settings** > **System** tab > **Clock** icon.

Shortcut: From the **Today** screen, tap the **Clock** icon to set the date.

2. Tap the down arrow by the date.
3. Tap the left or right arrow to select a month and year.
4. Tap a day.
5. Tap **OK**.
6. Tap **Yes** to save the date settings.

You need to reset your time zone, time, and date if:

- The location time (Home or Visiting) needs to be changed.
- All power to the Pocket PC is lost, which removes all saved settings.

- You perform a full reset of your Pocket PC.

Shortcut: From the **Today** screen, tap the **Clock** icon to set the time zone, time, and date.

Entering Owner Information

You can personalize your HP iPAQ Pocket PC by entering owner information. To enter owner information:

1. From the **Today** screen, tap **Start > Settings > Personal** tab > **Owner Information**.

Shortcut: From the **Today** screen, tap **Tap here to set owner information**.

2. Tap in the **Name** field. A keyboard appears at the bottom of the screen. Tap on the characters to enter your name.

NOTE: If you prefer, you can use Letter Recognizer, Microsoft Transcriber, or Block Recognizer to input information. Refer to Chapter 3, “Learning Input Methods,” for more information.

3. Tap the **Tab** key on the keyboard to move the cursor to the next field.
4. Continue entering whatever information you want to include.
5. To display owner information at startup, tap in the **Show information when device is turned on** checkbox.
6. Tap on the **Notes** tab to enter any notes.
7. Tap **OK** to save the information and return to the **Today** screen.

Setting a Password

You can set a password to prevent unauthorized access to or use of your Pocket PC.

1. From the **Start** menu, tap **Settings > Personal** tab > **Password**.

2. On the Password screen, tap the box next to **Prompt if device unused for**, then set the timed prompt.
3. Tap the circle next to **Simple 4 digit password** or next to **Strong alphanumeric password**.
4. Enter your password in the Password box using the screen keyboard and tap **OK**.

NOTE: Keep a record of your password in a safe place in case you forget it. If you are unable to retrieve your password, you must perform a hard reset on your Pocket PC and will lose settings and information that are not saved in ROM. See the section in this chapter “Performing a Hard Reset” for more information.

Resetting the Unit

Performing a Soft Reset

A soft reset (also known as a normal reset) stops all running applications, but does not erase any programs or saved data.



CAUTION: Be sure to save any **unsaved** data before performing a soft reset since soft reset erases all **unsaved** data.

To perform a soft reset:

1. Locate the recessed **Reset** button on the left side of your iPAQ Pocket PC.
2. Use the stylus to lightly press the **Reset** button until the screen fades.

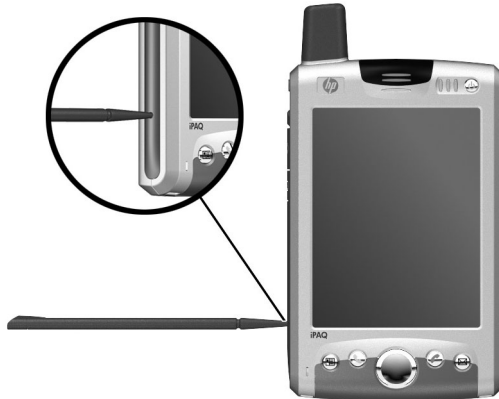

3. Remove the stylus to restart the Pocket PC.

The Pocket PC restarts and displays the **Today** screen.

Performing a Hard Reset

Perform a hard reset (also known as a full reset) when you want to clear all settings, programs, and data from RAM.



CAUTION: If you perform a hard reset, your Pocket PC returns to its default settings and loses all information that is not recorded in ROM or iPAQ File Store. Also, all of your GPRS connection methods are erased with a hard reset, except the default GPRS connection with T-Mobile if T-Mobile is your service provider.

To perform a hard reset:

1. Press and hold down the **Power** button.
2. While holding the Power button, use the stylus to lightly press the **Reset** button on the left side of the Pocket PC for about five seconds.

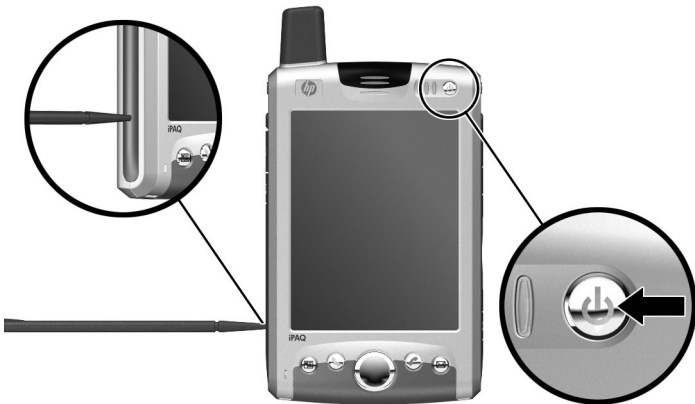

3. The Pocket PC screen fades and the device resets. Once the device resets and the screen comes back on, release the Power button and remove the stylus from the Reset button.

Aligning the Screen

When the Pocket PC is turned on for the first time, you are guided through a screen alignment process. You must realign your screen if:

- The Pocket PC does not respond accurately to your taps.
- You perform a hard reset of your Pocket PC.

To realign the Pocket PC screen:











1. From the **Start** menu, tap **Settings > System tab > Screen** icon.
2. Tap the **Align Screen** button.









Shortcut: To access the **Align Screen** application without tapping on the screen, push down and hold the 5-Way Navigation button, then press the Contacts application button on the bottom of the Pocket PC.





3. Tap the cross-hair object at each location. Be precise when tapping the cross-hair object.
4. Tap **OK**.

Status Icons

You may see the following status icons displayed on the Navigation or Command bar. Tap the icon on the screen to view more information related to the item.

Icon	Definition
	Inactive connection to computer or wireless network.
	Active connection to computer or wireless network.
	Microsoft ActiveSync is synchronizing.
	Speaker is on.
	Speaker is off or in mute position.
	GPRS service is registered and available if you are subscribed to the GPRS service.
	Active data connection to GPRS network.
	Active Wi-Fi connection to computer or wireless network.
	Phone is powered off.
	Phone is powered on.

Icon	Definition (Continued)
	Network is searching or unavailable.
	Phone connection unavailable or network error.
	Signal strength indicator for phone functions.
	A missed call. Tap this screen icon to view missed calls.
	Call Forwarding Active.
	iPAQ Wireless icon—Tap to display the iPAQ Wireless screen. The iPAQ Wireless screen provides a control center to turn all wireless activities on and off, and to configure their settings.
	One or more instant messages have been received. Tap this screen icon to view the messages.
	One or more e-mail/SMS/MMS, or voice messages have been received. Tap this screen icon to view the messages.
	Message Center indicates messages received from different communication areas such as phone or voice messages, e-mail/SMS/MMS, announcements, etc. Tap this screen icon to view all messages in the message center.

Icon	Definition (Continued)
	Tap to mute your phone conversation. Tap it again to continue the phone conversation.
	Event notification set to vibrate instead of alarm. To set to vibrate: Tap the Speaker icon in the Navigation bar and, in the pop-up menu, tap Vibrate .
	Battery power is low.
	Battery power is very low.
	Your iPAQ Pocket PC is connected with your personal computer. This icon appears in the Command bar only when there is an active connection.

Routine Care

To keep your Pocket PC in good condition and working properly, follow these guidelines:

- Keep your Pocket PC away from excessive moisture and temperature extremes.
- Do not expose your Pocket PC to liquids or precipitation.
- Do not place anything on top of your Pocket PC to prevent damage to the screen.
- Clean your Pocket PC by wiping the screen and the exterior with a soft, damp cloth lightly moistened only with water.
- Avoid exposing your Pocket PC to direct sunlight or strong ultraviolet light for extended periods of time.
- Avoid scratching the surface of the screen and banging it against hard objects.

- Use only the stylus that comes with your Pocket PC or an approved replacement on the screen to prevent scratching it.



CAUTION: To reduce the risk of damage to the internal components, do not spray liquid directly on the screen, or allow excess liquid to drip inside your Pocket PC. Using soap or other cleaning products on the screen may discolor the finish and damage it.

Traveling with Your Pocket PC

Use the following guidelines when traveling with your Pocket PC:

- Back up your information.
- Take a copy of your backup with you on an SD memory card.
- Disconnect all external devices.
- Take the AC Adapter and AC Charger Adapter with you.
- Keep your Pocket PC in a protective case and keep it in your carry-on luggage.
- For air travel, be sure to turn off the Phone, Bluetooth, and Wi-Fi. To turn off all wireless features, from the **Today** screen, tap the **iPAQ Wireless** icon in the Command bar, then tap the **ALL OFF** button on the iPAQ Wireless screen to turn all wireless features off.
- If you are traveling internationally, be sure you have the plug adapter appropriate for the country you are visiting.

Learning the Basics

Using the Today Screen

When you first turn on your Pocket PC, the **Today** screen displays. You can also display it by tapping **Start**, and **Today**. Use the **Today** screen to view:

- Date and time
- Owner information
- Upcoming appointments
- Unread and unsent messages
- Tasks that need to be completed

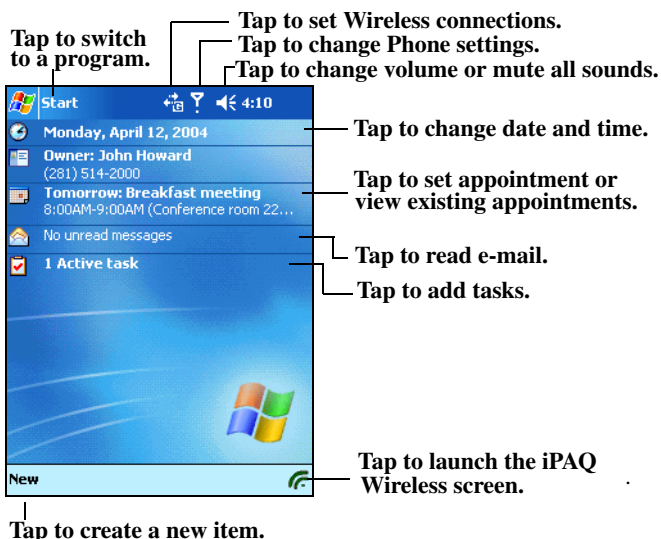

Navigation Bar

The Navigation bar is located at the top of the screen. It displays the active program, wireless status, and current time, and allows you to close screens. Use the **Start** menu to select a program.

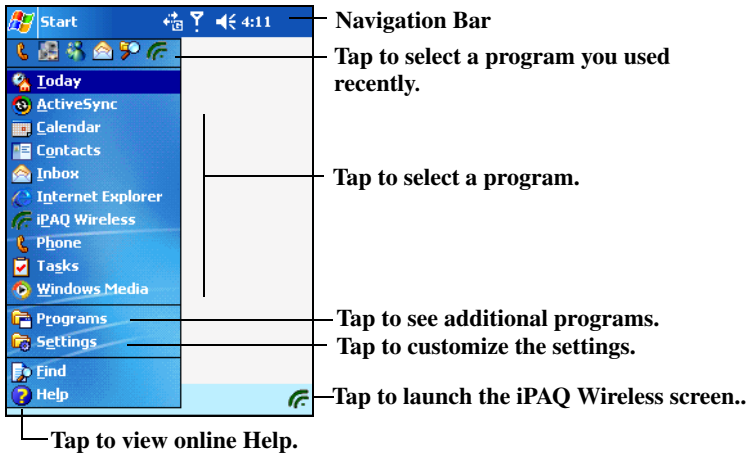

Command Bar

Within each program, use the Command bar located at the bottom of the screen to perform tasks. Tap **New** to create a new item in the current program.

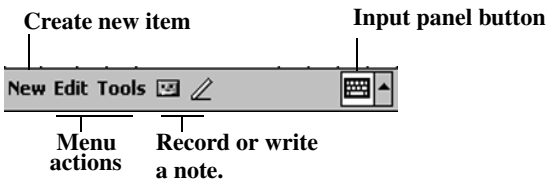

Pop-Up Menus

Pop-up menus allow you to quickly perform an action. Use the pop-up menu to cut, copy, rename, and delete an item, also send an e-mail or send a file to another device.

To access a pop-up menu, **tap** and **hold** the stylus on the item on which you want to perform the action. When the menu appears, tap the desired action, or tap anywhere outside the menu to close it without performing an action.

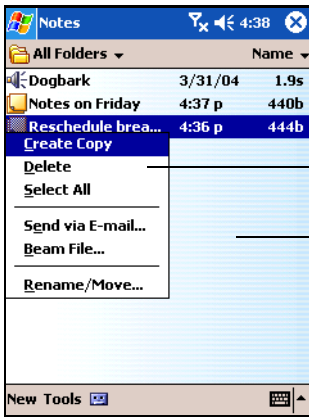

Tap and hold to display the pop-up menu.

Tap the action you want.

Tap outside the menu to close it without performing an action.

Creating information

From the **Today** screen, you can create new information, including:

- Appointments
- Contacts
- Excel Workbooks
- Messages
- Notes
- Tasks
- Word documents

1. Tap , or from the **Start** menu, tap **Today** > **New**.
2. Tap an option to create a new item.
3. Tap **OK** after you finish creating a new item.

Customizing the Today Screen

From the **Settings Today** screen, you can:

- Add a picture as the background.
- Select the information you see.
- Set the order of the information.
- Set when to see the **Today** screen.

1. Tap , or from the **Start** menu, tap **Settings** > **Personal** tab > **Today**.
2. Select **Use this picture as the background** checkbox.

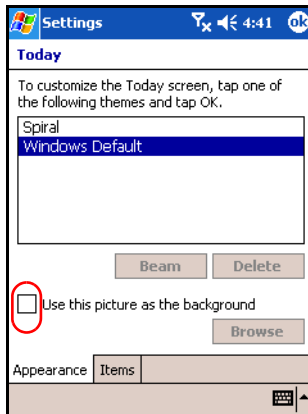

3. Tap **Browse** to select a picture from File Explorer.

4. Tap the **Items** tab to select or reorder the information on the **Today** screen.

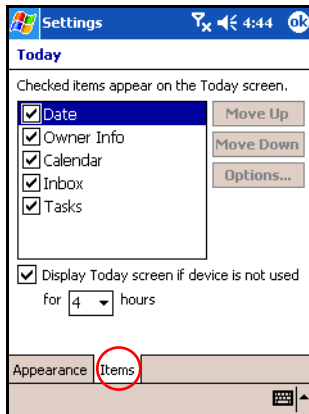

5. Tap an item to highlight it.
6. Tap **Move Up** or **Move Down** to change the order of items on the **Today** screen.

NOTE: You cannot change the placement of the **Date** on the **Today** screen.

7. Tap the down arrow associated with **Display Today screen if device is not used for...hours** checkbox to determine how many hours must pass before the **Today** screen displays.
8. Tap **OK**.

Customizing the Application Buttons

You can change the Contacts and Inbox programs currently assigned to two of the application buttons on the bottom of the Pocket PC. You can replace these assignments with two programs that you use the most.

NOTE: The Phone application buttons **cannot** be reassigned.

To change the Button assignment:

1. From the **Start** menu, tap **Settings > Personal tab > Buttons**.
2. Highlight the button to be changed, for instance - **Button 1**.
3. Tap the down arrow in the **Button Assignment box** and select your preferred program.
4. Tap **OK**.

Locking the Application Buttons

To prevent the application buttons on your Pocket PC from accidentally turning on and discharging the battery, the Buttons Settings include a Lock feature to disable the buttons.

To disable the buttons when the Pocket PC is in standby:

1. From the **Start** menu, tap **Settings > Personal tab > Buttons**.
2. Tap the **Lock** tab.
3. Tap the check box next to **Disable all buttons except power button**.
4. Tap **OK**.

Using Applications

Opening Applications

Open any application on your Pocket PC from the **Start** menu.

NOTE: You can also open an application by assigning it to one of the two available Application Buttons. The Phone Application Buttons **cannot be reassigned**. To assign the Application Buttons, from the **Today** screen, tap **Start > Settings > Buttons**.

To open an application:

1. Tap **Start > Programs**.
2. Tap the desired application title or logo.

Minimizing Applications

To minimize an open application, tap the **x** at the top right of the screen.

Closing Applications

Applications automatically close based on available memory. However, if your Pocket PC is running slowly, you can close applications by manually closing them.

1. From the **Start** menu, tap **Settings > System tab > Memory > Running Programs** tab.
2. Tap **Stop All** or select a particular application, then tap **Stop**.

NOTE: To bring a currently running program to the foreground, tap **Activate**.

Installing Applications

Install applications on your Pocket PC from your:

- Computer by using Microsoft ActiveSync.
- Pocket PC if the application file has a .cab extension.
- Pocket PC or your computer by copying an application file that has an .exe or .cef extension.

When installing applications, look for the correct version for your HP iPAQ h6300 model or Microsoft Windows Mobile™ 2003 Software for Pocket PC Edition.

- Follow the instructions provided with the application and by the Installation Wizard to install applications from your computer.
- Tap the application file in File Explorer on your Pocket PC and follow the instructions on the Installation Wizard to install applications on your Pocket PC.

Backing Up Information

Use iPAQ Backup or Microsoft ActiveSync Backup to back up and restore information on your Pocket PC.

NOTE: iPAQ Backup is already installed on the Pocket PC. You must install ActiveSync on your computer before using ActiveSync Backup.

To help reduce the chance of losing information, you should back up information on a regular schedule.

Backup/Restore using iPAQ Backup

iPAQ Backup saves your data in a backup file. You may designate a file name and a location for the file to be saved. iPAQ Backup backs up to a memory card, main memory, or the iPAQ File Store folder. Close all programs on your Pocket PC before backing up or restoring your information.



CAUTION: Restoring your information replaces the current information on your Pocket PC with the information saved in your backup. If you perform a hard reset on your Pocket PC, any user installed information stored in main memory including backup files will be deleted. For this reason, it is suggested that backup files always be saved to a memory card or to the iPAQ File Store folder.

To backup/restore using iPAQ Backup:

1. From the **Start** menu, tap **Programs > iPAQ Backup**.
2. Tap **Options > Switch to Advanced Mode** and select the files and folders to be backed up or restored.
3. Tap the ... box next to **File** to select the name, location, and folder name for backed-up data.
4. Tap **OK**.
5. Press the **Backup** or **Restore** button, and press the **Start** button on the next screen.

Backup/Restore Using ActiveSync

Close all programs on your Pocket PC before backing up or restoring your information.



CAUTION: Restoring your information replaces the current information on your Pocket PC with the information saved in your backup.

To backup/restore using ActiveSync:

1. Be sure the Pocket PC is connected to your computer.
2. From your computer, open Microsoft ActiveSync. From the **Start** menu, click **Programs > Microsoft ActiveSync**.
3. From the **Tools** menu in ActiveSync, click **Backup/Restore**.
4. Click the **Backup** or **Restore** tab, and select your options.
5. Click **Backup Now** or **Restore Now**.

Using iPAQ File Store Folder

You can install programs and save files to the iPAQ File Store folder, which is accessed from File Explorer on your Pocket PC.

Programs and files stored in iPAQ File Store are stored in ROM and are saved if you perform a full reset of your Pocket PC or if the battery discharges completely.

To save to iPAQ File Store:

1. Copy the files to be saved to the iPAQ File Store folder.
2. From the **Start** menu, tap **Programs > File Explorer > My Device > iPAQ File Store**.
3. Paste the selected files.

NOTE: Before saving files to the iPAQ File Store folder, it is a good idea to determine how much memory is available in the folder. To view the amount of memory, from the **Start** menu, tap **Settings > System** tab > **Memory > Storage Card** tab, then select **iPAQ File Store** from the drop-down menu.

Learning Input Methods

Using Input Software



CAUTION: To avoid damaging your Pocket PC screen, always use a stylus or your finger. **Never** use a pen or any type of metal pointer on the screen.

To input information to your Pocket PC, you can tap the keyboard or write with the Letter Recognizer, Microsoft Transcriber, or Block Recognizer in any application. You can use the stylus to draw and write on the screen in the Notes application and from any **Notes** tab in the Calendar, Contacts, and Tasks applications.

NOTE: A Removable Thumb Keyboard is included on certain Pocket PC models. For information on using this keyboard, see the section “Using the Removable Thumb Keyboard” in this chapter.

Changing Word Suggestion Options

As you type or write, the Pocket PC suggests words for you in a box above the keyboard, Letter Recognizer, or Block Recognizer, but not in the Transcriber.

You determine:

- If words are suggested.
- The number of letters you enter before a word is suggested.
- The number of words that are suggested per entry.

To change settings for word suggestions:

1. From the **Start** menu, tap **Settings > Personal tab > Input**.
2. Tap the **Word Completion** tab.

SHORTCUT: From within any application, tap the **up arrow** next to the Input Panel icon and tap **Options > Word Completion** tab.



3. Tap the down arrow associated with letters and select the number of letters you want to type before a word is suggested.

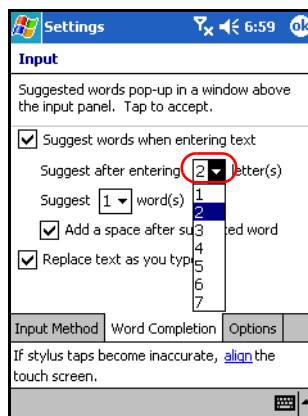

4. Tap the down arrow associated with words and select the number of words you want suggested.

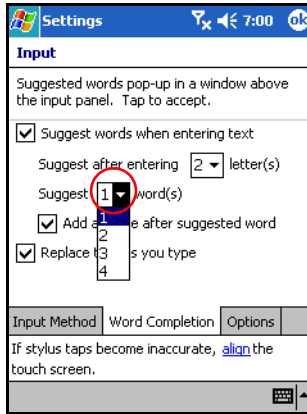

5. Tap **OK**.

NOTE: If you do not want any words suggested, tap the checkbox to remove the checkmark next to **Suggest words when entering text**.

Using the On-Screen Keyboard

Use the stylus to tap letters, numbers, and symbols on the on-screen keyboard to enter typed text directly onto the screen.

NOTE: A question mark within a program indicates a **Help** file. Tap the **?** to open the Help file.

1. From any application, tap the up arrow next to the **Input Panel** icon.

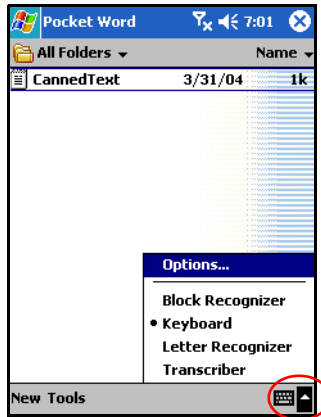

2. Tap **Keyboard** to display a keyboard on the screen.

NOTE: To see symbols on the keyboard, tap the **123** or **Shift** key.

3. Tap a letter, symbol, or number to enter information.
4. Tap **OK**.

Writing with the Stylus and the Letter Recognizer

Use the stylus and Letter Recognizer to write letters, numbers, and symbols on the screen. Create words and sentences by writing in uppercase (ABC), lowercase (abc), and symbols (123) as instructed here.

To write with the stylus and Letter Recognizer:

1. From any application, tap the up arrow next to the **Input Panel** icon.
2. Tap **Letter Recognizer**.
3. Write a letter or symbol between the dashed line and baseline.

- a. To display in uppercase, write a letter between the hatch marks labeled **ABC**.
- b. To display in lowercase, write a letter between the hatch marks labeled **abc**.
- c. Write a number or draw a symbol between the hatch marks labeled **123**.

What you write will be converted to text.

NOTE: For the Letter Recognizer to work effectively, write characters between the dashed line and baseline.

- If you are writing a letter like “p,” write the top portion within the dashed line and baseline, and the tail portion below the baseline.
 - If you writing a letter like “b,” write the bottom portion within the dashed line and baseline, and the top portion above the dashed line.
-

Writing with the Stylus and Microsoft Transcriber

Use the stylus and Microsoft Transcriber to write words, letters, numbers, and symbols anywhere on the screen.

1. From any application, tap the up arrow next to the **Input Panel** icon.
2. Tap **Transcriber** to display the **Transcriber Intro** screen.
3. Tap **OK**.
4. Tap **New** at the bottom of the screen.

5. Begin writing on the screen. What you write will be converted to text.

NOTE: To “teach” Transcriber your style of writing, tap on the “a” icon at the bottom of the screen to display the **Letter Shapes** screen and follow the instructions.

Writing with the Stylus and Block Recognizer

Write letters, numbers, and symbols using the stylus and Block Recognizer. Create words and sentences by writing letters and numbers in specific areas.

1. From any application, tap the up arrow next to the **Input Panel** button.
2. Tap **Block Recognizer**.

NOTE: For online Help, tap the **?**

3. Write a word, letter, or symbol between the hatch marks.
 - a. To type text, write a letter between the hatch marks labeled “abc.”
 - b. To type numbers or symbols, write a number or symbol between the hatch marks labeled “123.”

What you write will be converted to text.

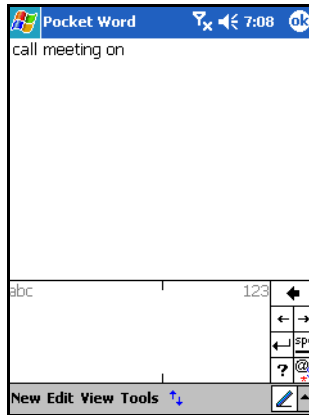

Drawing and Writing on the Screen

Use the stylus as a pen to draw and write on the screen in the Notes program or from the **Notes** tab in Calendar, Contacts, or Tasks.

1. From the **Start** menu, tap **Notes > New**.
2. Draw and write on the screen.
3. Tap the **Pen** icon.
4. Tap **OK**.

Converting Writing to Text

You can convert your writing to text when you write with the stylus in the Notes program or from the Notes tab in:

- Calendar
- Contacts
- Tasks

To convert writing to text:

1. From the **Start** menu, tap **Notes**.

NOTE: Otherwise, tap the **Notes** tab in Calendar, Contacts, or Tasks.

2. Tap a note to open it.
3. Tap **Tools**.
4. Tap **Recognize**.

NOTE: To convert a particular word or phrase, highlight it before you tap **Recognize**. If a word is not recognized, it will not be converted.

5. Tap **OK**.

Using the Removable Thumb Keyboard

NOTE: Some iPAQ Pocket PC models may not include the keyboard.

The iPAQ Removable Thumb Keyboard is a convenient, portable input device for your HP iPAQ Pocket PC h6300 Series product. The Thumb Keyboard does not require batteries and it uses a very small amount of power that is drawn from your Pocket PC.

With the Thumb Keyboard, you can:



- Easily type text into your iPAQ Pocket PC.
 - Quickly access your favorite iPAQ Pocket PC applications.
 - Enter commands with special function keys.
 - Use Send and End buttons for phone calls.
-

NOTE: If you regularly use an additional keyboard such as the HP Foldable Keyboard with your iPAQ Pocket PC, you may need to manually enable and disable the appropriate keyboards before use.

Keyboard Components



When the Thumb Keyboard is installed on the Pocket PC, use the microphone and buttons on the keyboard to perform the same functions as on the Pocket PC.

❶	Microphone	Speak into the microphone for phone calls or to record notes.
❷	 Phone Button	Press to answer or send phone calls, access the dialer keypad, or activate the speakerphone function.
❸	 Phone Button	Press and Hold to turn on/off the Phone or end a call.
❹	Inbox Button	Press to display your e-mail Inbox.
❺	Contacts Button	Press to display your Contacts list.

Keyboard Connectors

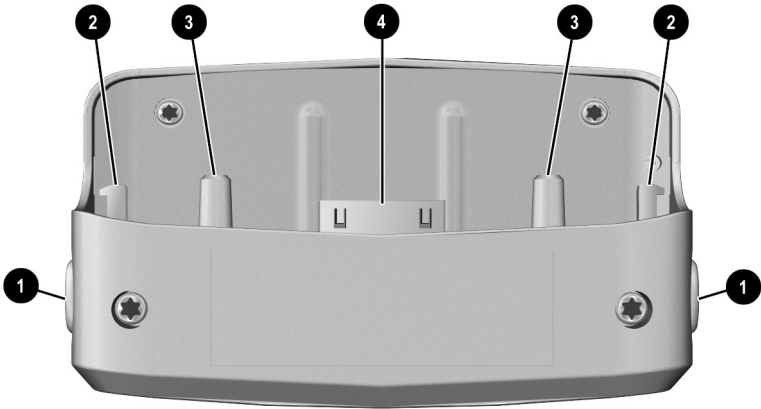

-
- | | |
|-----------------------------------|---|
| ❶ Disconnect Buttons | Press the buttons on each side of the keyboard to disconnect the keyboard from the Pocket PC. |
| ❷ Release Connectors | When the above buttons are pressed in, these connectors release the keyboard from the Pocket PC. |
| ❸ Guides | Align the guides with the holes on the bottom of the Pocket PC when attaching the keyboard. |
| ❹ Communications Connector | This connector must be connected to the Communications port on the bottom of the Pocket PC for the keyboard to operate. |
-

Connecting the Keyboard to Your iPAQ Pocket PC

To connect the Removable Thumb Keyboard to your iPAQ Pocket PC h6300 Series:

1. Line up the guides on the bottom of the keyboard with the holes on the bottom of the Pocket PC.
2. Slide the Pocket PC into the Thumb Keyboard until it is firmly seated.



NOTE: Repeat the above procedure to connect the Thumb Keyboard to your iPAQ Pocket PC with an Extended Battery attached.

Checking the Keyboard Connection

After you've connected the keyboard to your iPAQ Pocket PC, if you press a key on the keyboard and the letter does not register, perform the following steps to check your keyboard connection:

1. Be sure the Thumb Keyboard is securely connected to your iPAQ Pocket PC.
2. If the connection is secure, go to **Start > Settings > System tab > iPAQ Keyboard** and be sure the **Enable Keyboard** check box is checked.
3. Insert your cursor in the **Test here** box and tap the keyboard to see if it types characters in the box.
4. If characters appear in the Test here box, tap **OK**.
5. Use your stylus to press the **Reset** button on the left side of your iPAQ Pocket PC.

Disconnecting the Keyboard

To disconnect the keyboard from your iPAQ Pocket PC, push in the two buttons on the side of the keyboard to release it, then pull the Pocket PC from the keyboard.

Configuring the Keyboard

You can configure several features on your Thumb Keyboard. To customize your keyboard:







1. On your Pocket PC, select **Start > Settings > System tab > iPAQ Keyboard**.
2. Select the **Setting** tab.
3. Do one or more of the following:
 - Tap the **Enable Keyboard** check box to enable or disable the keyboard functionality.
 - Tap the **Enable Sound** check box to hear a click every time you press a key.

- ❑ Tap and slide the **Delay until Repeat** scale to change the speed at which the keyboard types a character when individual keys are pressed.
- ❑ Tap and slide the **Key Repeat Rate** scale to change the speed at which the keyboard repeatedly types a character when the key is held down.
- ❑ Tap in the **Test here:** field to verify the keyboard settings before exiting the Removable Thumb Keyboard application.

Using the Function and Shortcut Keys

The Thumb Keyboard keys perform additional functions when pressed in the combinations indicated.





The Blue Key is a function (Fn) key on the left side of the keyboard. Blue symbols used in conjunction with the Blue Key are located on the upper left of the keys.

Keystroke Combination	Action
Blue Key  + any key	Enters characters printed on the upper left of the key (indicated in blue).
Blue Key  pressed twice	Toggles on blue keys. Press Blue Key once to toggle off.
Blue Key  + down arrow	Page down
Blue Key  + up arrow	Page up
Blue Key  + left arrow	Scrolls left
Blue Key  + right arrow	Scrolls right
Blue Key  + OK	Closes program

“Sticky” Keys

The integrated keyboard uses a “Sticky Key” feature for the **Shift** and **Blue Fn** keys (known as “key modifiers”). This means that when you enter a number or symbol requiring a combination of keys to be pressed, the key modifier will stay engaged until you press the second key. It is not necessary to press both keys at the same time.

Special Keys

Key	Function	Description
	Function (Fn) key	“Sticky Key” for invoking alternate function or symbols on most keys.
 + 	Symbol (Sym) or space bar key (English only)	Used for selecting alternate characters and symbols to replace a character.
	Symbol (Sym) or space bar key (all other languages)	Used for selecting alternate characters and symbols to replace a character.

Note: To type a backslash (\) on the Thumb keyboard, first press the **Blue Fn Key + P** to create a forward slash (/), then the **Symbol/Space Bar key** to modify it as necessary. Refer to the following “Accent Characters” section for more information on modifying characters.

Accent Characters

To type any of the accent characters, press the letter you require to be accented, then press the **Blue Fn Key** and the **Symbol/Space bar**. Continue pressing the Blue Fn Key and the Space bar until you reach the desired special character. For example, if you press **a**, then the **Blue Key** and the **Symbol/Space Bar**, the **a** will result in **à**. If you press the Blue

Fn Key and Space Bar again, the **à** will change to **á**. If you continue to press the Blue Fn Key and the Space Bar, the accent mark over the **a** will continue to change.

To type a capital letter with an accent, press and hold down the **Shift** key and press the desired letter, then press the **Blue Fn Key** and the **Space Bar**. For example, press **Shift + a**, then press the **Blue Fn Key** and the **Space Bar**, the **A** will result in **À**.

Refer to the table below for a list of special characters.

NOTE: It is recommended that you print this table for future reference.

Original Character	Modified Character
a	à á â ã ä å ã ä æ
A	À Á Â Ã Ä Å Æ Æ Æ
c	ç ć Ć ©
C	Ç Ć Ć ©
d	đ
D	Ð
e	è é ê ë ě
E	È É Ê Ë Ě
i	ì í î ï
l	ì í î ï
l	ł
L	Ł
n	ñ

Original Character	Modified Character (Continued)
N	Ñ
o	ò ó ô õ ö ø œ
O	Ò Ó Ô Õ Ö Ø Œ
P	þ þ
P	þ þ
r	®
R	®
s	ş š ß
S	Ş Š ß
t	ţ
T	Ţ
u	ù ú û ü
U	Ù Ú Û Ü
y	ý
Y	Ý
z	ž ž
Z	Ž Ž
\$	€ £ ¥
/	\
"	' « »

Original Character	Modified Character (<i>Continued</i>)
([{ < «
)] } > »
+	± & - _
!	¡ ? ¿
.	: , ;
*	#
@	~
%	^

Disabling the Thumb Keyboard

If you would like to use a different keyboard with your iPAQ Pocket PC, you need to disable the Thumb Keyboard first.

To disable the Thumb Keyboard:

1. Select **Start** > **Settings** > **System** tab > **iPAQ Keyboard**.
2. Select the **Setting** tab.
3. Clear the **Enable Keyboard** check box.
4. Tap **OK**.
5. Disconnect the keyboard.

You are now ready to install and connect another keyboard.

Using the Phone Features

Use the iPAQ Pocket PC phone to make and receive telephone calls and send and receive SMS (Short Message Service) and MMS (Multimedia Message Service) messages. Your mobile phone service provider may provide other useful services such as voice mail.

The phone can also be used to connect to an Internet Service Provider (ISP) or work network so you can browse the Web and read e-mail. You can connect to the Internet or work network over GPRS (General Packet Radio Service), or you can use GSM (Global System for Mobile Communications) for dial-up access.

For information on establishing GSM/GPRS data connections, refer to Chapter 6, “Making Your Data Connections.”

SIM Card

A SIM (Subscriber Identity Module) card is required to operate the phone features on your iPAQ Pocket PC. The SIM card is a plastic card embedded with a computer chip that stores and transacts data. After the SIM card is activated by your mobile phone service provider, the computer chip will contain information about your phone number, service, registration information, and contacts, as well as memory to store speed dial numbers and text or SMS/MMS messages that you receive.

With the exception of emergency calls, the SIM card must be inserted into the SIM slot under the battery on the back of the Pocket PC in order for voice/data calls to work.

To dial an emergency number, from the Phone keypad, tap the emergency number appropriate for your region, and then tap **Talk** or **Send**.

NOTE: See your local telephone directory for emergency numbers used in your area.

Inserting a SIM Card

NOTE: If the battery is already installed, you must remove it before inserting the SIM card. For more information on this, see Chapter 13, “Managing the Battery.”

To insert the SIM card into the Pocket PC:

1. On the back of your Pocket PC, push the SIM tray to the right to unlock ❶ and lift up ❷ to open it.
2. Insert the SIM card (with the gold side facing the inside of the tray) into the SIM tray by aligning the notched corner on the card with the notched corner in the SIM slot ❸.

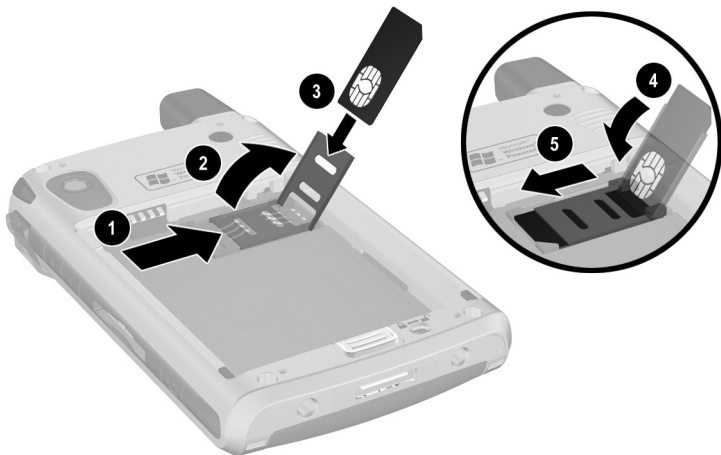

3. Press the SIM tray (with the SIM card inserted) down ④ into the SIM slot and lock it into place ⑤ by sliding the tray to the left.

NOTE: Repeat the same steps to remove the SIM card from the SIM tray.

Activating Your Phone Service

Before you are able to use the phone feature on your Pocket PC, you will need to subscribe with a mobile phone service provider.

NOTE: If you have purchased a prepaid SIM card to use with your iPAQ Pocket PC, the following information is not applicable.

You can place a phone call to the service provider to activate your mobile phone service. Your carrier may require the following information to activate your card:

- SIM Card Serial Number (printed on the box label or on the back of the SIM card)
- IMEI Number (printed on the system label under the removable battery)

Your mobile phone service representative will give you your wireless phone number and walk you through setting up your service.

Phone Features

The following features are supported on your iPAQ Pocket PC; however, these features must be activated by your mobile phone service provider:

- Call Forwarding
- CSD—Circuit Switched Data
- GPRS—General Packet Radio Service

- International Dialing
- International Roaming
- Internet access
- SMS/MMS—Short Message Service/Multimedia Message Service
- Voice Mail
- VPN—Virtual Private network
- WAP—Wireless Application Protocol

You can obtain additional information on these services from your mobile phone service provider.

Your PIN

After your SIM card is activated, it may be configured with a PIN (Personal Identification Number) to prevent unauthorized use of your mobile phone.

NOTE: Emergency phone calls do not require entering a PIN.

You can disable your PIN; however, for security reasons, it is recommended that you keep it enabled. While enabled, you must enter your PIN every time you turn on your phone features.



CAUTION: After three consecutive, incorrect PINs are entered, the SIM card locks to prevent further use. If the letters **PUK** (PIN Unblocking Key) display on your Pocket PC screen, you have locked your SIM card and must enter your PUK on the screen to unlock it. If you did not receive a PUK with your SIM card, you must contact your service provider to unlock it.

If your Pocket PC is ever stolen or lost, the PIN will safeguard your phone against fraudulent use.

To enable your PIN:









1. From the Phone keypad, tap **Tools > Options > Phone** tab.









2. Select **Require PIN when phone is used**.

NOTE: To change the PIN at any time, tap **CHANGE PIN**.

NOTE: To safeguard your Pocket PC device from unauthorized use, see Chapter 1, “Getting to Know Your HP iPAQ Pocket PC.”



Phone Buttons and Icons

Phone Icons	Definition
	<ul style="list-style-type: none"> ■ Press this Application Button to answer a call, access the dialer keypad, and send a call. ■ Press and hold this Button to activate the speakerphone function.
	Press and hold this Application Button to turn on/off the phone or end a call.
	Phone is powered off.
	Phone is powered on.
	Network is searching or unavailable.
	Phone connection unavailable or network error.
	Signal strength indicator for phone functions.
	Call missed. Tap this icon to view missed calls.
	Call Forwarding Active

Phone Icons	Definition (Continued)
	Phone Volume is active.
	Microphone is in mute position.
	GPRS Service is available.
	Active data connection to GPRS network.
	Event notifications set to vibrate instead of alarm. To set to vibrate: Tap Speaker icon in the Navigation bar and in the pop-up menu, tap Vibrate .
	One or more instant messages have been received. Tap this icon to view messages.
	One or more e-mail/SMS/MMS or voicemail messages have been received. Tap this icon to view messages.
	Message Center indicates messages received from different communication areas such as phone or voice messages, e-mail/SMS/MMS, announcements, etc. Tap this screen icon to view all messages in the message center.

Checking Your Connection and Signal Strength

After you insert the activated SIM card into your Pocket PC, your unit will connect to your service provider's network.

The powered on icon () indicates that you are connected to your service provider's network. After that, a full strength is indicated by the signal strength icon (). The number of vertical bars in the icon diminish as the signal strength diminishes. The phone icon () indicates no signal.

Selecting a Frequency Band

Your iPAQ Pocket PC has an integrated GSM/GPRS feature that supports four different frequency bands which allows for international roaming. When traveling between countries and wireless network operators, it may be necessary to change the frequency bands of the GSM/GPRS connection settings. HP has provided a selection feature that initiates an automatic search for network frequency bands when your home bands are not available. This automatic selection feature is the default setting on your Pocket PC.

NOTE: Automatic band selection may not be available on all models.

To change the frequency band manually:

1. From the **Phone dialer pad**, tap **Tools > Options > Band**.
2. Tap the square or circle next to one of the following items:
 - Automatic (default setting)
 - North America (850/1900)
 - Europe, Asia (900/1800)

NOTE: Automatic band selection may not be available on all models.



3. Tap **OK**.

Select the correct frequency band for the country or region you are traveling through. To change back to automatic selection, repeat step 1 and select **Automatic**.

Turning the Phone On and Off

You can turn your Phone on and off while keeping your actual Pocket PC turned on.

There are several ways to turn on your Phone:

- Press and hold the Red  application button on the front of your Pocket PC, or
- From the **Start** menu, tap **Phone**. Enter the phone number you wish to dial on the screen, and tap **Yes** when asked if you want to turn on the phone.
- From the **Today** screen, tap the **iPAQ Wireless** icon in the Command bar at the bottom of the screen, then tap the **Phone** button.
- If the Pocket PC is in Flight Mode, from the Today screen, tap the  icon in the Navigation bar and, from the Pop-up menu, tap **Turn off flight mode**.

NOTE: Flight mode turns on/off all wireless functions on your Pocket PC. Turn on Flight mode when you are traveling by air to prevent a wireless function from automatically turning on.

There are several ways to turn off your phone:

- Press and hold the Red  application button on the front of the unit, or

- From the **Today** screen, tap the **iPAQ Wireless** icon in the Command bar, then tap the **Phone** button to turn off the phone.
- From the **Today** Screen, tap the  icon in the Navigation bar and, from the Pop-up menu, tap **Turn on flight mode**.

NOTE: Leave the phone turned on to receive calls when your Pocket PC is powered off.

You can use other programs on your device during a call. To quickly switch back to Phone, tap the Green  **application button**, or tap **Start > Phone**.

HP Profiles

- To access HP Profiles, from the **Start** menu, tap **Settings > System tab > HP profiles**.

HP Profiles allows you to create system profiles for alerts, display power, and wireless settings to match your current environment or location. You can set up and name profiles to use at different times and for different functions. For example, you can set a certain Ring type or tone to be silent or vibrate when you are in a meeting, or loud when you are outdoors in a crowd.

There are four button icons that allow you to modify settings for Alert, Display, Power, and Wireless.

There are five predefined profiles—Silent, Normal, Meeting, Outdoor, and User. You can rename these profiles, but you cannot add or delete any profiles.

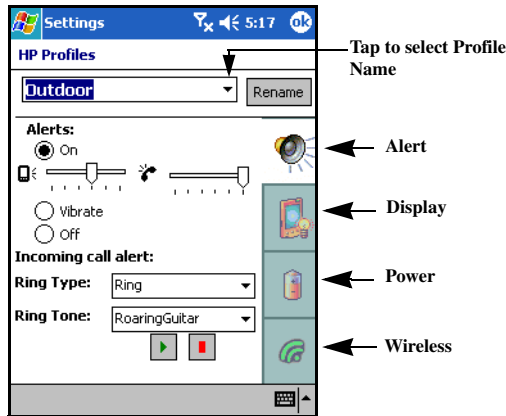

Setting a Profile

To set a profile:

1. From the **Start** menu, tap **Settings > System** tab > **HP Profiles** icon.
2. Tap the **<Current>** box on the HP Profiles screen and, from the drop-down list, select a profile name or rename a profile.

NOTE: Clicking the Rename button brings up a dialog box. Enter the new name in the dialog box and tap **OK**.

3. On the right of the screen, tap the icon button that you want to set (**Alert, Display, Power, or Wireless**).
4. Select the desired settings:

- a. Use **Alert** to select a ring type and tone, set the type to On, Vibrate, or Off, and set the volumes for device and phone.
 - b. Use **Display** to adjust backlight brightness and set a timer to turn off the backlight if device is not used.
 - c. Use **Power** to set a timer to turn off the power if device is not used.
 - d. Use **Wireless** to keep wireless settings On or Off (wireless, phone, and Bluetooth).
5. Tap **OK** when you have finished setting the profile.

Switching a Profile

To quickly switch a profile from within any application:

1. Press and hold the **Power button** to bring up the quick access menu.

NOTE: The quick access menu includes five tasks in addition to the profile selections that allow you to switch tasks.

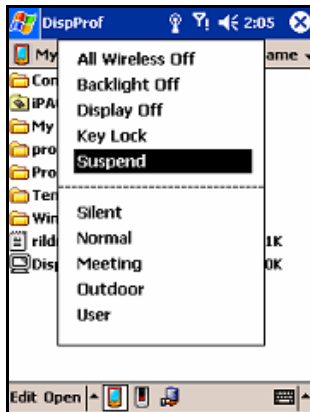

2. Tap the desired profile.

NOTE: The quick access menu disappears after 30 seconds.

NOTE: When the Backlight is adjusted to its lowest setting, it cannot be turned on from the quick access menu. It can only be turned back on by accessing the **Start** menu > **Settings** > **System** > **Backlight** > **Brightness** tab and adjusting the brightness level.

Making and Receiving Phone Calls

You can now make local or long distance domestic calls and, if you requested setup, you can also make international calls.

Making a Call

When you turn on the Phone, the Phone keypad displays on the Pocket PC screen.

- From the Phone keypad, tap the number you want to call, and then tap **Talk** or press the **Send** button.

Refer to the following sections for alternate ways to make a call:

- “Making a Call From Contacts”
- “Making a Call Using Speed Dial”
- “Making a Call from Call History”
- “Making a Conference Call”

Answering a Call

When you receive a phone call, the iPAQ Pocket PC rings or vibrates and a message will appear on the screen, giving you an option to either answer or ignore the incoming call.

- Tap **Answer** or press the Green  application button to receive the call.

NOTE: To silence the phone and reject the call, tap **Ignore**. This may send the caller to your voice mail or send out a busy signal, depending on your service provider.

Ending a Call

When your phone call is finished, tap **End** on the Phone keypad or press and hold the Red  Application Button to end the call.

Making a Call from Contacts

- From the Contacts list, tap and hold the contact's phone number, then tap **Call Work**, **Call Home**, or **Call Mobile**.
- To make a call from an open contact, tap the number you want to call.

SIM Contacts Help

When switching SIM cards between devices, use SIM Contacts to copy contacts from a new SIM card to Contacts on your device.

- ❑ To copy a contact from your SIM card onto your device, in SIM Contacts, select the contact you want to copy to your device and tap **COPY NOW**.
- ❑ To verify that your contacts have been copied to your device, switch to **Contacts** and search for the added contacts.

NOTE: This feature may not be available on all models.

Making a Call Using Speed Dial

- From the Phone keypad, tap **Speed Dial**, and then select the speed dial location number of the desired contact. You can also press and hold the speed dial location number assigned to a contact directly from the Phone keypad.

NOTE:

- To dial a one-digit speed dial number from the Phone keypad, tap and hold a single keypad key.
 - To dial a two-digit speed dial number from the Phone keypad, tap the first digit, then tap and hold the second digit.
-

Creating a Speed Dial Entry

You can create up to 99 speed dial entries to call frequently-dialed numbers. Before you can create a speed dial entry for a phone number, that number must already exist in Contacts.

1. From the Phone keypad, tap **Speed Dial > New**.
2. Tap the desired contact name and number.
3. In the **Location** field, tap the Up/Down arrows to select an available location to assign as the new speed dial entry. The first speed dial location is reserved for your voice mail.
4. Tap **OK**.

Creating a Speed Dial Entry from Contacts

1. Tap and hold the contact name.
2. Tap **Add to Speed Dial**.
3. Tap the Up/Down arrows to select an available location to assign as the new speed dial entry.
4. Tap **OK**.

Editing a Speed Dial Entry

1. From the **Speed Dial** list, tap and hold the contact name in the box to the right of the assigned speed dial number.
2. Tap **Edit** or **Delete**.

Making a Call from Call History

- From the Phone keypad, tap **Call History**, and then tap the icon next to the desired number.

Making a Conference Call

You can create a three-way conference call between yourself and two other parties.

- From the Phone keypad, dial the first number, tap **Talk** and after the call is initiated, tap **Hold**, dial the second number, tap **Talk** and then tap **Conference**.

Adjusting Phone Volume

During a phone call, press the up (+) or down (-) buttons located on the right side of the Pocket PC to adjust the Phone volume.

NOTE: The Phone volume can only be adjusted during a phone call.

Enabling the Mute Function

During a call, you can mute your microphone so that the person with whom you are speaking cannot hear you, but you can still hear him or her. This is useful if you do not want the other person to hear a conversation or background noise on your side of the call.

- From the Phone keypad, tap the microphone icon  in the Command bar to mute or unmute a call.

Setting Ring Tones

1. Tap  > **Settings** > **System** tab > **HP Profiles**.
2. On the **Sound Notification** tab, tap the drop-down list under **Ring type** and select the type of ring to be used.
3. Then tap the drop-down list under **Ring tone** and select the ring tone to be used.
4. To listen to the selected sounds, tap the **Play** icon. When you are finished listening, tap the red **Stop** icon.

NOTE: To use custom.wav, .mid, or .wma files as ring tones, use ActiveSync on your personal computer to copy the file to the My Device\Windows\Rings folder on your device. Then, select the sound from the **Ring tone** list.

To control tapping sounds for the keypad:

1. From the **Start** menu, tap **Settings** > **Personal** tab > **Sounds & Notifications**.
2. Place a checkmark in the box next to Screen taps and select **Soft** or **Loud**. If set to **Off**, a tone is not played.
3. Tap **OK** to save the settings.

Changing Ring Tones

You can select a different sound to notify you of incoming calls.

1. From the Phone keypad, tap **Tools** > **Options**.
2. Tap the Ring tone list, and select the sound you want to use.

Changing Keypad Tone

You can change the tone you hear when entering a phone number on the keypad. If set to Tones, the tone is heard continuously for as long as the number on the keypad is pressed. If set to Beep, the tone is heard only for one or two seconds.

1. From the Phone keypad, tap **Tools** > **Options**.



2. Tap the Keypad list, and select the option you want.

To prevent tones from being heard when entering a phone number, select **Off**.

Enabling Speakerphone Mode

Your iPAQ Pocket PC has a speakerphone mode that allows you to talk hands-free or allows other people to listen to the caller.

To enable the speakerphone mode:

1. First make a phone call.
2. Hold down the Green  application button until the speakerphone dialog box comes on and the speakerphone icon () appears in the top Navigation bar.

SHORTCUT: From the Phone keypad, tap **Tools > Speakerphone**.

3. To turn off the speakerphone, hold down the  application button again.



WARNING: Do not leave the phone in speakerphone mode and hold it to your ear, the sound may temporarily impair your hearing.

Taking Notes During a Call

- To create a note during a call, tap the Note icon  in the Command bar and enter or record your note.

Using Voice Mail

The first speed dial location is set as a default for your voice mailbox number. When you insert your SIM card into your Pocket PC, it sets as default the voice mailbox number of your mobile service provider. You may need to configure your phone to the Voice Mail setting by dialing or setting the Voice Mail dial number.

To retrieve your voice mail:

- With the Phone turned on and the Phone keypad visible on the screen, press and release the left side of the 5-way navigation button, select **1** Voice Mail, then press .

Putting a Call on Hold

During a phone call, tap **Hold** on the Phone keypad to put the call on hold. The call on hold appears on the top right of the dialer screen. You may switch between calls by tapping on the call on hold.

Using Call Waiting

Call waiting notifies you of incoming calls when you are already in a phone session.

To activate Call Waiting:

1. From the Phone keypad, tap **Tools > Options > Services** tab.
2. Tap **Call Waiting > Get Settings**.
3. Select **Notify me**.

NOTE: To stop using call waiting, select **Do not notify me**.

To use Call Waiting to answer an incoming call during a phone conversation, tap **Answer** to move the current phone call to **Call Waiting**. The phone call on **Call Waiting** displays on the screen. Tap **Ignore** if you do not want to answer the incoming call.

Displaying Caller ID

You can display your caller ID when placing a phone call.

1. From the Phone keypad, tap **Tools > Options > Services** tab.
2. Tap **Caller ID > Get Settings**.

3. Select **Everyone**.

NOTE: To prevent your caller ID from being displayed to others, select **No One**.

Blocking Calls

Use call barring to block certain types of incoming and/or outgoing calls.

1. From the Phone keypad, type **Tools > Options > Services** tab.
2. Tap **Call Barring > Get Settings**.
3. Select the type of incoming and/or outgoing calls you want to block.

Forwarding Calls

Use call forwarding to forward all incoming calls to a different number.

1. From the Phone keypad, tap **Tools > Options > Services** tab.
2. Tap **Call Forwarding > Get Settings**.
3. Select **Forward all incoming phone calls**, and specify the phone number to receive forwarded calls.

You can also use call forwarding to forward incoming calls to a different number based on your situation.



- Select **Unavailable** to forward calls only when your phone is turned off or you are unreachable.
- Select **Busy** to forward calls only when the line is busy.

- ❑ Select **No answer** to forward calls only when you can't answer your phone.

NOTE: To stop using Call Forwarding, clear the box next to **Forward all incoming phone calls**.

Change the System Volume

You can adjust the volume for system sounds, such as the sound you hear when you tap on program names and menu options.



- Tap the  icon in the Navigation bar.
- In the pop-up volume box, move the system volume () slider to the desired volume level.

Select **On**, **Vibrate**, or **Off** to quickly change both the system and ringer volume settings.

NOTE: You can also press the volume control on your device to quickly change both the ringer and system volume settings.

Change the Ringer Volume

There may be times when you want to change the ringer volume on your device. For example, you may want to increase the ringer volume when you're anticipating an important call, or immediately silence the ringer when you receive a call during a meeting or when you're in a quiet environment.

- Tap the  icon in the Navigation bar.
- In the pop-up volume box, move the ringer volume () slider to the desired volume level.

Select **On**, **Vibrate**, or **Off** to quickly change both the ringer and system volume settings.

You can also press the volume control on your device to quickly change both the ringer and system volume settings.

Changing the Phone Settings

Tap **Start > Settings > Phone**.

You can customize phone settings such as the ring type and ring tone to be used for incoming calls, and the keypad tone to be used when entering phone numbers. You can also protect your phone from unauthorized use with a PIN.

- To change phone settings from the Phone keypad, tap **Tools > Options > Phone** tab.

From the **Phone** tab, you can change the following items:

- Ring type—Tap the **Ring type** list and select the desired option.
- Ring tone—Tap the **Ring tone** list and select the sound you want.
NOTE: To use custom .wav, .mid, or .wma files as ring tones, use ActiveSync on your personal computer to copy the file to the /Windows/Rings folder on your device. Then, select the sound from the **Ring tone** list.
- Keypad tone—Tap the **Keypad** list, and select the option you want.
- Secure your Phone

Changing Services Settings

You can change service settings by either of the following methods:

- From the **Start** menu, tap **Settings > Phone > Services** tab, tap a service, and then tap **Get Settings**.
- From the Phone keypad, tap **Tools > Options > Services** tab, tap a service, and then tap **Get Settings**.

You can configure settings for phone services you subscribe to through your mobile phone service provider. For example, you may want to block certain types of incoming and/or outgoing calls, forward incoming calls to a different phone number based on your situation, be notified of incoming calls when you're already in a phone session, or let others know your identity when making calls.

Viewing Available GSM/GPRS Networks

You can view all GSM/GPRS wireless networks available to you.

1. From the Phone keypad, tap **Tools > Options > Network** tab.
2. Tap **Find Network**.

Changing Network Settings

You can change Network Settings by either of the following methods:

- From the **Start** menu, tap **Settings > Phone > Network** tab.
- From the Phone keypad, tap **Tools > Options > Network** tab. The GSM/GPRS connection your device is currently using will be listed at the top of the screen.

You can view available networks, determine the order in which your phone accesses another network if the current one is unavailable, and specify whether you want to change networks manually or automatically. The current network will remain active until you change it, lose your signal, or change your SIM card.

Manually Selecting a Network

You may want to manually select a different wireless network to use, instead of your device automatically doing this for you. For example, you may want to control costs by knowing when connectivity for your current, selected network is unavailable, and deciding whether you want to select a different network to use.

1. From the Phone keypad, tap **Tools > Options > Network** tab.
2. Under Network selection, select **Manual** and select the network you want to use.

NOTE: When your current network is unavailable, tap **Select Network**, and manually select a different network to use.

Configuring Your Pocket PC for Your SIM Card

When the SIM card connects to your service provider's network, it may be updated by your service provider to include new network parameters for faster connection. The GPRS Settings Manager automatically updates your Pocket PC's device files with the new network parameters on your SIM card.

At times, you may need to manually edit the network settings or create your own personal network settings. To do that, you will need to modify the GPRS Settings.

The GPRS Settings Manager has the following features:

- Automatically detects the carrier and sets up the GPRS connection information.

- Launches on all hard and soft resets to check for SIM changes and updates the network settings.
- Provides the User with the ability to edit network settings including GPRS, CSD, SMS, MMS, and WAP information.
- Provides the User with the ability to create their own network settings and save them under a user defined name in the iPAQ File Store folder.

Modifying the GPRS Network Settings

The first time you use your SIM Card, the GPRS (General Packet Radio Service) Settings Manager automatically updates changes in the network parameters if there are any. You can modify these settings to your own preference or create your own network settings.

NOTE: If the automatic network detection fails, you can manually relaunch it by pressing the **Automatic detection** button on the GSM/GPRS Settings screen below.

1. To access the GSM/GPRS Settings, from the **Start** menu, tap **Settings > Connections** tab > **GSM/GPRS Settings** icon.
2. On the GSM/GPRS Settings screen:

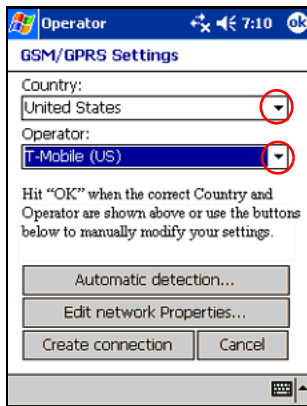

- a. Under **Country**, tap the down arrow in the box to open the drop-down menu, then select the correct country name.
- b. Under **Operator**, tap the down arrow in the box to open the drop-down menu, then select the correct operator name.

NOTE: If your operator name appears in the drop-down list, it is recommended that you use that connection and, if needed, edit the default settings.
- c. Tap **OK** when the correct Country and Operator are shown, or tap the following buttons to manually modify your settings.
- d. Tap one of the following, then continue with the following appropriate section:
 - ◆ **Automatic Detection** launches the automatic detection for the network number and the operator default.
 - ◆ **Edit Network Properties** to edit the network settings. This button is grayed out unless an operator is selected on the screen.
 - ◆ **Create Connection** to create your own operator connection setting.
 - ◆ **Cancel** to close the application without saving any of the new settings.

NOTE: If a change to the network properties or a new connection is created, a Warning displays asking you to save the new data.

Automatic Detection

1. When you tap on **Automatic Detection** on the GSM/GPRS Settings screen, it launches the network number and operator default.
2. Tap **OK** to accept it and exit the GSM/GPRS Settings screen.

Editing Network Properties

Tapping on the **Edit Network Properties** bar on the GSM/GPRS Settings screen gives you access to the following areas:

- ❑ Internet Connection Information—Walks you through the different settings for GPRS (General Packet Radio Service) and CSD (Circuit Switched Data) connections.
- ❑ SMS Text Message—Allows you to modify the SMS (Short Message Service) service center number.
- ❑ MMS Multimedia Messages—Allows you to modify the MMS (Multimedia Message Service) Center address.
- ❑ WAP Information—Allows you to modify the WAP (Wireless Application Protocol) gateway and Port.



Editing an Internet Connection

If you tapped **Internet Connection Information** on the above Edit Properties screen:

1. Under **Select a Country**, tap on the drop-down arrow and select a country from the list.
2. Enter a name for the connection such as the carrier name.
3. Tap **Next**.

If you select the GPRS Network:

1. Select the **GPRS** network to edit.
2. Tap **Next**.
3. After **APN**: enter the Access Point Name of the server you are attempting to connect.
4. After **Name**: enter the Log on for your connection.
5. After **Password**: enter the password for your connection.
6. Tap **Next**.
7. On the next screen, tap one of the following:
 - Dynamic IP address
 - Static IP address
8. Tap **Next**.
9. On the next screen, tap one of the following:
 - Dynamic DNS addresses
 - Static DNS addresses
10. Tap **OK**.

If you select the CSD Network:

1. Select the **CSD** network to edit.
2. Tap **Next**.
3. After **Number**: enter the Phone Number of the server you are attempting to connect.
4. After **Name**: enter the Login for your connection such as mtaylor@yahoo.com.
5. After **Password**: enter the password for your connection.
6. Tap **Next**.
7. On the next screen, tap one of the following:
 - Dynamic IP address

- Static IP address

8. Tap **OK**.

Editing SMS Text Message Settings

If you tap **SMS Text Message** on the Edit Properties screen:

1. Under **Enter the Service Center Number**, enter the Phone Number to which all SMS messages will be sent for delivery by the network.
2. Tap **OK**.

Editing MMS Multimedia Messages Settings

If you tapped **MMS Multimedia Messages** on the Edit Properties screen:

1. Under **Enter the MMS Center Address**, enter the URL where all MMS messages are sent for delivery by the network (for example, enter <http://mms.mobilelife.co.th>).
2. Enter the following information:
 - APN:** Access Point Name of the MMS server being connected.
 - Name:** Log on name for the MMS server.
 - Password:** Password for the MMS server.
3. Tap **OK**.

Editing WAP Information

If you tapped **WAP Information** on the Edit Properties screen:

1. Under **WAP Settings**, enter the IP address and port for the WAP Gateway.
2. Tap **OK**.

Creating a Connection

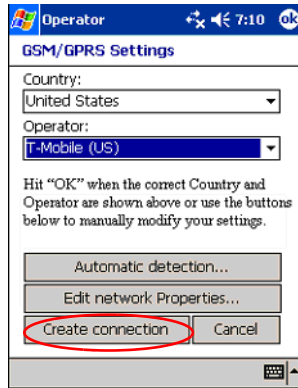

1. When you tap **Create Connection** on the GSM/GPRS Settings screen, the next screen requests the Internet connection name:
 - a. In the **Country** drop-down menu, select a country for the carrier you are creating.
 - b. Enter a name for the connection you are creating.
 - c. Tap **Next**.
2. On the next screen, select the network to use:
 - Tap **GPRS** to connect to a high-speed GSM data network.
 - Tap **CSD** (Circuit Switched Data) to connect to your own ISP over the Voice channel.
3. After you have selected a network, tap **Next**.

NOTE: If you tapped CSD above, skip the following section and go to the section titled “Creating a CSD Connection.”

Creating a GPRS Connection

1. If you tapped GPRS, the next screen requires you to fill in the following GPRS configuration information. You can get this information from your GPRS Service Provider if you do not have it.
 - APN:** Access Point Name of the server that you want to connect.
 - Name:** Log On name for your connection.
 - Password:** Password for your connection.
2. Tap **Next** to continue.
3. In the next screen, select the IP Address to be used during your connection:
 - Dynamic IP Address
 - Static IP Address
4. Tap **Next**.
5. In the next screen, configure the name-servers to be used during your connection.
 - a. Select one of the following:
 - ◆ Dynamic IP addresses
 - ◆ Static IP addresses
 - b. Enter the required information (DNS, DNS aux, WINS, and WINS aux).
6. Tap **Next**.

NOTE: When you are creating a new connection, the next screen to display at this point is the SMS Text Message screen. Skip to the section on “Creating an SMS Text Message Connection.”

Creating a CSD Connection

1. If you tapped CSD (Circuit Switched Data) on the network selection screen, the next screen requires you to fill in the following CSD configuration information. You can get this information from your CSD Service Provider (ISP provider) if you do not have it.
 - Number:** The phone number of the ISP that you want to connect to.
 - Name:** Log On name for your connection.
 - Password:** Password for your connection.
 - Tap **Next** to continue.
2. On the next screen, select the IP Address to be used during your connection:
 - Dynamic IP Address
 - Static IP Address
3. Tap **Next**.
4. On the next screen, select the name-server to be used during your connection.
 - Dynamic IP address
 - Static IP address
5. Enter the required information (DNS, DNS aux, WINS, and WINX aux).
6. Tap **Next**.

NOTE: When you are creating a new connection, the next screen to display is the SMS Text Messaging screen.

Creating an SMS Text Message Connection

1. On the SMS Text Messaging screen, under **Enter the Service Center Number** box, enter the phone number to which all SMS messages will be sent for delivery by the network.

2. Tap **Next** to go to the MMS Multimedia Messages settings screen.

Creating an MMS Multimedia Messages Connection

1. On the MMS Multimedia Messages screen, under **Enter the MMS Center Address** box, enter the URL or path to which all MMS messages are sent to for delivery by the network. (For example: <http://mms.mobilelife.co.th>)
2. Enter the following information:
 - APN:** Access Point Name of the MMS server you are connecting to.
 - Name:** Log on name for the MMS server.
 - Password:** Password for the MMS server.
3. Tap **Next** to go to the WAP Settings screen.

Creating a WAP Gateway

1. On the WAP Settings screen, enter the following information:
 - IP address of the WAP Gateway.
 - Port information for the WAP Gateway.
2. Tap **OK**.

Failed Automatic SIM Detection

If the SIM card is not detected by the application:

- Check to see if the SIM card is present in the Pocket PC. If it is not present, insert the SIM card and relaunch the application.
- If the SIM card is not recognized by the application, create a new connection.

TTY Functionality for the Hearing-Impaired

NOTE: The TTY software application is included on the Companion CD and must be downloaded onto the Pocket PC before it can be enabled.

This Pocket PC supports TTY (Tele-typewriter) functionality. This functionality allows hearing-impaired persons to communicate using existing telephony infrastructure, including cellular phones. To achieve this, separately purchased TTY devices must be connected to the telephones on both ends of a telephone call session, and the TTY software application must be downloaded from the Companion CD onto the Pocket PC. The sending TTY device generates a distinct audio tone for every supported character, and these tones are decoded and converted back into text on the receiving TTY device.

Due to the use of audio compression codecs in modern digital cellular telephones, these TTY audio tones may be unintentionally distorted while being transmitted through cellular telephones. In order for TTY devices to continue to work in cellular networks, the cellular telephone must be set into a mode that optimizes the compression codec to handle TTY tones instead of the human voice.

NOTE: For information on connecting TTY devices to the iPAQ Pocket PC, refer to the TTY device manufacturer's documentation.

Enabling TTY Support

Before connecting the optional TTY device to the phone, you must enable TTY support in order to prepare the Pocket PC Phone to expect a TTY device to be connected.

To enable TTY support:

1. From the **Start** menu, tap **Settings > Personal** tab > **TTY** icon.
2. Place a checkmark in the **Enable TTY support** box by tapping it.
3. Tap **OK**.
4. Connect the optional TTY device or plug to the headphone as stated in the device manufacturer's documentation and connect the headphone to the Pocket PC. This connection activates the TTY audio mode.

Making a Phone Call Using the TTY Device

1. Press the green phone button on the bottom front of the Pocket PC to launch the dialer keypad, then turn on the phone functions of the Pocket PC.
2. Dial the phone number of the person you are trying to reach who also has a TTY device connected to their phone.
3. When the phone call is answered, start typing onto the TTY keyboard.

The letters typed into the machine are turned into electrical signals that travel over regular telephone lines. When the signals reach their destination (another TTY), they are converted back into letters which appear on a display screen, are printed out on paper, or both.

When you are finished typing your phone conversation, the person on the other end of the line may begin typing their answers or comments to you.

4. To end a phone call, press and hold the red phone button on the bottom of the Pocket PC.

NOTE: TTY audio mode activation may not be possible while a telephone call is already in progress.

NOTE:

- If a normal headset is connected while TTY support is enabled, the audio quality may be decreased.
 - If a Bluetooth headset is connected while TTY support is enabled, the audio quality will not change because TTY audio mode has not been activated.
 - However, if you make a phone call using a Bluetooth headset while TTY mode is enabled **AND** a plug has been inserted into the headphone jack, TTY audio mode will be activated and voice quality will decrease.
-

Deactivating TTY Audio Mode

To deactivate TTY audio mode:

- Remove the plug from the headphone jack or
- Uncheck the **Enable TTY support** checkbox in the **Settings > Connections** tab.

Disabling TTY Support

To disable TTY support:

1. From the **Start** menu, tap **Settings > Connections**.
2. Uncheck the **Enable TTY support** box.

NOTE: It has not been determined if deactivation by either method is possible while a TTY telephone call is in progress.

Managing Multiple Wireless Connections

Using the iPAQ Wireless Manager

The iPAQ Wireless Manager application provides a centralized control for you to manage all wireless features on the Pocket PC.

The iPAQ Wireless screen has individual power buttons to turn wireless features on and off—one at a time, and one All Off button to turn off all wireless features at the same time. The screen also includes Settings buttons to configure GPRS, Wi-Fi, and Bluetooth.

- To access the iPAQ Wireless screen, from the **Today** screen, tap the **iPAQ Wireless** icon () in the Command bar at the bottom of the screen.

The iPAQ Wireless screen displays showing the current state of all wireless activities ( - x indicates Off).

NOTE: For an alternate path to the iPAQ Wireless screen, tap **Start** menu > **iPAQ Wireless**.

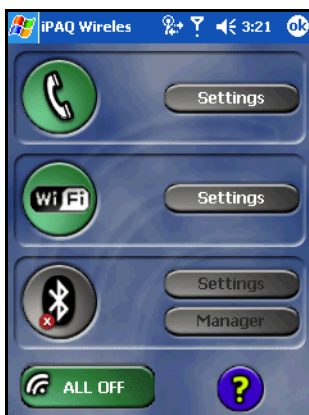

- To power on one or more wireless activities, tap the desired buttons.
- To power off one or more wireless activities, tap the desired buttons or tap the **All Off** button () to power off all activities.

Power Buttons

All Power buttons (with the exception of the All Off button) display:

- Gray background with an **x** () when they are powered off.
- Amber background when they are powered on and signals are available, but not connected.
- Green background when they are powered on and connected or associated with another device.

NOTE: If a button does not immediately respond when tapped, it may be busy performing a task you requested.

The **All Off** button displays:

- Gray background with the x () when all wireless features are powered off.
- Green background when one or more wireless features are powered on.

Settings Buttons

Each of the four settings buttons—Phone Settings, Wi-Fi Settings, Bluetooth Settings, and Bluetooth Manager— only function when they are enabled. In enabled status, press the Settings button to open a page with information about configuration and settings for that particular wireless feature.

NOTE: You cannot access these configuration pages if you press the Settings buttons while in a disabled state.

Phone Settings Button

First, tap the **Phone Power** button to power it on; then press the **Settings** button to open the configuration screen.

NOTE: For information on configuring the Phone settings, refer to Chapter 4, “Using the Phone Features” and Chapter 6, “Making Your Data Connections.”

Wi-Fi Settings Button

First, tap the **Wi-Fi Power** button to power it on; then press the **Settings** button to open the Wi-Fi configuration screen.

NOTE: For information on configuring the Wi-Fi settings, refer to Chapter 7, “Using Wi-Fi.”





Bluetooth Settings and Manager Buttons

First press the **Bluetooth Power** button to power it on; then press either the **Settings** or **Manager** button to open the Bluetooth settings and configuration screens.

NOTE: For information on configuring Bluetooth settings or manager, refer to Chapter 8, “Using Bluetooth.”

Managing Data Connections

When you tap a Data Connectivity icon in the Navigation bar, it opens a drop-down Connectivity box that displays the status of your wireless data connections and information about which service is connected. From this drop-down box, you can also create new connections, access wireless settings menus, and turn on or off the wireless features.

Data Connectivity Icons	
	Inactive connection to computer or wireless network.
	Active connection to computer or wireless network.
	GPRS service is registered and available if you are subscribed to the GPRS service.
	Active data connection to GPRS network.
	Active Wi-Fi connection.

Tap a Data Connectivity icon to display the drop-down Connectivity box.



Making Your Data Connections

The iPAQ Pocket PC h6300 Series offers you the most comprehensive set of wireless capabilities to keep you connected in or out of the office. With Global System for Mobile Communications/General Packet Radio Service (GSM/GPRS), Wireless Fidelity (Wi-Fi) also known as Wireless Local Area Network (WLAN), and Bluetooth integrated into a single device, you have broad coverage offering high speed access to the Internet, and to business and personal information.

You can use the following options to get connected:

- Use the Wi-Fi technology integrated on your Pocket PC to connect to a Virtual Private Network (VPN)
- Use the Wi-Fi technology integrated on your Pocket PC to remotely connect to your mobile Internet Service Provider (ISP), or connect to hotspots in public places
- Make a wireless GSM/GPRS connection to place a phone call or send or receive e-mail and text or Short Message Service/Multimedia Message Service (SMS/MMS) messages.
- Transfer information between Bluetooth enabled devices
- Transfer information between two Infrared (IrDA) enabled ports

NOTE: Use of dial-up and wireless Internet, e-mail, corporate networks, and other wireless communications, such as Bluetooth-enabled devices, may require separately purchased additional hardware and other compatible equipment, in addition to a separately purchased service contract. Check with your service provider for availability and coverage in your area. Not all Web content may be available. Some Web content may require installation of additional software.

NOTE: For more information on this subject, refer to the Help file on your Pocket PC by tapping **Start > Help > Connections**.

Impact of Data Connection When Phone Call is Received

Class B mobile phones may be attached to both GPRS and GSM services, using one service at a time. Class B enables making/receiving a voice call, or sending/receiving an SMS during a GPRS connection. During voice calls or SMS, GPRS services are suspended and then resumed automatically after the call or SMS session has ended.

Using GSM/GPRS Connections

GSM/GPRS technology is integrated into your HP iPAQ Pocket PC. To send or receive data over a GSM/GPRS network, you must have an account with a mobile telephone service provider that supports GSM/GPRS data services and an activated SIM card. The service provider must enable the GPRS data features on your account to activate it.

For a list of GSM/GPRS service providers, go to your GSM/GPRS service provider's Web site.

Creating a GPRS Connection

A General Packet Radio Service (GPRS) connection provides high-speed data transfer and is typically used for Web browsing and to send and receive small bursts of data such as e-mail and MMS messages.

To create a GPRS connection, you must subscribe with a GSM service provider that supports GPRS. After you configure your GPRS connection and connect to the GPRS network, you may be required to authenticate GPRS.

NOTE: Your service provider must enable the GPRS features on your account.

Configuring your GPRS connection on your Pocket PC

1. From the **Start** menu, tap **Settings > Connections** tab > **Connections** icon.
2. Select **Add a new modem connection** from either the **ISP** section or **My Work Network** section.
3. Enter a descriptive name for the connection (for example, **Phone Dialup** or anything you want).
4. In the **Select a modem** list, tap **Cellular Line (GPRS)**.
5. Tap **Next**.
6. Under **Access Point Name**, enter the APN provided by your GPRS service provider.
7. Tap **Next**.
8. If required, enter your **User name**, **Password** and, if provided by your ISP or network administrator, your **Domain name**.
You should not need to change any settings in **Advanced**. Most ISPs now use a dynamically assigned address. If your GPRS service provider specified the IP addresses for your

DNS servers, tap **Advanced**, then tap the **Name Servers** tab. Select **Use specific server addresses**, and then enter the DNS addresses provided by your GPRS service provider. Tap **OK**.

9. Tap **Finish**.

Connecting to the GPRS Network

1. From the **Start** menu, tap **Settings > Connections** tab > **Connections** icon.
2. In the drop-down list, select the service you want to use.
3. Tap **Connect**.

Your service provider can provide additional information on connecting to the Internet using GPRS.

Creating a GSM Connection

Global System for Mobile Communications (GSM) technology is used to make mobile phone calls and provide data service with roaming capabilities throughout the world.

To create a cellular GSM connection, you must first subscribe to Circuit Switching Data (CSD), and you must have your phone number. Make sure you insert your activated SIM card into your iPAQ Pocket PC before you configure your GSM connection.

After you configure the connection, dial the phone number of the remote server you are connecting to, and use the GSM connection to browse the Internet or send or receive e-mail.

Configuring your GSM connection on your Pocket PC

1. From the **Start** menu, tap **Settings > Connections** tab > **Connections** icon.
2. In the drop-down list, select **Add a new modem connection** from either **ISP** or **My Work Network**.
3. Enter a descriptive name for the connection (for example, iPAQ dialup).

4. In the **Select a modem** list, select **Cellular Line**.
5. Tap **Next**.
6. You should not need to change any settings in Advanced. Most ISPs and Networks use a dynamically assigned address. If the ISP or Network you are using does not use a dynamically assigned address, enter the connection number that was given to you by your ISP or Network Administrator and tap **Next**.
7. Enter your User name, Password, and Domain if provided by your ISP or Network Administrator.
8. Tap **Finish**.

Dialing a GSM Connection

1. From the **Start** menu, tap **Settings > Connections** tab > **Connections** icon.
2. In the drop-down list, select the service you want to use.
3. Tap **Connect**.

Closing a GSM Connection

1. First, close Inbox or Pocket Internet Explorer if they are open.
2. Then tap the **Data Connections** icon  in the Navigation bar of the Today screen, and tap **End**.

Switching Between GPRS and Wi-Fi

NOTE: Before the wireless networks can perform these activities, you must have already set up your GPRS and Wi-Fi connections on your iPAQ Pocket PC.

If you have an active GPRS connection on your Pocket PC and walk into an area with a Wi-Fi network, the system forces a GPRS disconnect and connects to the available Wi-Fi network.

If you want to connect back to GPRS while you are still in Wi-Fi network coverage, you can manually connect to the GPRS network by tapping **Start > Settings > Connections** tab > **GPRS**, or by turning off the Wi-Fi. For information on making a GPRS connection, refer to the section in this chapter on “Connecting to GPRS.”

When you move out of Wi-Fi range and launch a wireless application such as Pocket Internet Explorer or e-mail, the system automatically connects back to the GPRS network.

NOTE: Automatic switching cannot be disabled.

To disconnect from Wi-Fi, from the **Today** screen, tap the **iPAQ Wireless** icon () in the Command bar, then tap the Wi-Fi icon.

Switching Between Wi-Fi Access Points

Switching between access points (AP) is automatic and does not require any user input. To see which AP you are connected to, launch iPAQ Wireless.

You can prioritize the profiles by accessing the Wi-Fi settings and prioritizing the connection.

Setting Up a WAP Browser

Wireless application protocol (WAP) delivers content in a reduced format to fit the Pocket PC screen. WAP protocol can accommodate the low memory limitations of handheld devices and the low-bandwidth limitations of a wireless-handheld connection.

NOTE: This protocol requires a GPRS connection.

Before you can use the WAP browser, you must set it up.

1. From the **Start** menu, tap **Settings > Connections** tab > **Connections**.

2. Under **My Work Network**, select **Manage Existing Connections > Proxy Settings** tab.
3. Place a checkmark in the two boxes on the **My Work Network** screen and tap **Advanced**.
4. Next to **WAP** enter **Server** and **Port** information supplied by your Mobile Service Provider, and tap **OK**.

Viewing WAP Pages

Once you have set up your WAP browser, you can view WAP pages by starting a GSM or GPRS connection and using Pocket Internet Explorer. When you enter a Web site using Pocket Internet Explorer, remember WAP addresses are prefixed by “wsp” not “http” (example: wsp://www.xxx.com).

Connecting to a Private Network

Setting Up VPN Server Connections

A VPN connection enables you to securely connect to a private or a corporate network, via the Internet. To set up a VPN server connection:

1. Contact your network administrator for your user name, password, domain name, TCP/IP settings, and host name or IP address of the VPN server.
2. Be sure Wi-Fi is powered on.
3. From the **Today** screen, tap **Start > Settings > Connections** tab > **Connections > Tasks** tab.
4. Under **My Work Network**, tap **Add a new VPN server connection**.
5. Follow the instructions in the **New Connection** wizard.

Note: For online Help for any screen in the New Connection wizard or while changing settings, tap the **?**.

Setting Up Proxy Server Settings

If you are connected to your ISP or private network during synchronization, your Pocket PC should download proper proxy settings from your computer. If these settings are not on your computer or need to be changed, you will need to set them up manually. To set up proxy server settings:

1. Contact your ISP or network administrator for the proxy server name, server type, port, type of Socks protocol used, and your user name and password.
2. Be sure Wi-Fi is powered on.
3. From the **Today** screen, tap **Start > Settings > Connections** tab > **Connections > Tasks** tab.
4. Under **My Work Network**, tap **Edit my proxy server > Proxy Settings** tab.
5. Tap the **This network connects to the Internet** and **This network uses a proxy server to connect to the Internet** checkboxes.
6. In the **Proxy server** box, enter the proxy server name.
7. If you need to change port number or proxy server type settings, tap the **Advanced** button and change the desired settings.
8. Tap **OK**.

Managing Your E-mail

You can send and receive e-mail messages by connecting directly to an e-mail server using GSM/GPRS or Wi-Fi. If you have already created a connection to a network or an ISP, you must still set up an e-mail account in Inbox. To set up your e-mail account, see Chapter 11, “Using Inbox and Messaging.”

NOTE: The network or ISP connection must use a POP3 or IMAP4 e-mail server and an SMTP gateway.

Entering an Internet Address

With Pocket Internet Explorer and a connection to the Internet, you can view Web sites on your Pocket PC by typing an Internet address in the **Address** bar.

NOTE: Some Web content may require installation of additional software.

To enter an Internet address on your Pocket PC:

1. From the **Start** menu, tap **Internet Explorer > Address Bar**.
-

NOTE: If the Address Bar is not visible, tap the **View** tab > **Address Bar** to turn it on.

2. Enter the Internet address in the **Address** bar.
3. Tap the **Go** icon.

Using a Favorites List

With Pocket Internet Explorer and a connection to the Internet, you can view Web sites on your Pocket PC by selecting one from your **Favorites** list.

To select a Web site from your **Favorites** list:

1. From the **Start** menu, tap **Internet Explorer**.
2. Tap the **Favorites** icon and the Web site you want to view.

Using Wi-Fi

Getting Acquainted

With wireless access, you do not need to use cables to connect your Pocket PC to the Internet. However, you must have a Wireless Access Point to be able to transmit data to and from your wireless device. Your Pocket PC can connect to an 802.11b Wi-Fi network or connect directly to other Wi-Fi enabled devices.

NOTE: The term “Wi-Fi” refers to any type of 802.11 Wireless Local Area Network, whether 802.11b, 802.11a, dual-band, etc.

With Wi-Fi, you can:

- Access the Internet
- Send and receive e-mail
- Access corporate network information
- Use virtual private networks (VPN) for secure remote access
- Use hotspots for wireless connectivity

NOTE: Use of dial-up and wireless Internet, e-mail, corporate networks, and other wireless communications, such as Bluetooth-enabled devices, may require separately purchased additional hardware and other compatible equipment, in addition to a standard WLAN infrastructure and a separately purchased service contract. Check with your service provider for availability and coverage in your area. Some Web sites may not be formatted to fit Pocket PC screens and may require installation of additional software.

Learning the Terms

It is recommended that you become familiar with the following terms as you begin to use Wi-Fi technology.

Term	Definition
802.11b	The standard specification for wireless local area networks, often called Wi-Fi.
802.1x	A standard designed to enhance the security of Wi-Fi networks by providing an authentication framework.
Authentication	The verification of the identity of a person or process. For example, in a communication system, authentication verifies that messages really come from their stated source, similar to a signature on a document. Logically, authentication precedes authorization even though they might appear to occur simultaneously.
Authorization	The process of granting or denying someone access to a network resource.
Data Encryption	A conversion process that is used for protecting data.

Term	Definition (<i>Continued</i>)
Device-to-computer or ad-hoc	This mode does not use access points. It is used in peer-to-peer network communications. All peers must be configured on the same channel.
Hotspots	Public or private areas where there is a wireless access point available.
Infrastructure	This connection mode uses wireless access points to connect to networks.
Internet Protocol (IP) Address	A number that identifies each sender or receiver of information (sent in packets) across the internet.
Proxy server	Networks may use a proxy server as a gateway to the Internet if they are not directly connected to the Internet.
Service Set Identifier (SSID)	A sequence of characters that uniquely identifies a Wi-Fi network. This identification number uses a maximum number of 32 characters and is case sensitive.
Virtual Private Network	A way of providing users (for example, remote offices, telecommuters, etc.) secure access to their organization's network by way of the Internet.
Wired Equivalent Privacy (WEP)	A security protocol designed to provide Wi-Fi networks with the same level of security usually expected on a Local Area Network.
Wireless Fidelity (Wi-Fi)	The term used for a high-frequency wireless network.

Term	Definition (<i>Continued</i>)
Wireless Local Area Network (WLAN)	A wireless network in which a mobile user can connect to a local area network through a wireless connection.
Encryption (WEP), LEAP or IEEE 802.1X	A set of security services used to protect 802.11 networks from unauthorized access.
Wireless Access Point	Physical hardware or computer software that acts as a hub for users of wireless devices to connect to a local area network.

Getting Started with Wi-Fi

Powering Wi-Fi On or Off

To use Wi-Fi on your Pocket PC, you need to turn on Wi-Fi and set up your device.

To turn Wi-Fi on or off:

1. From the **Today** screen, tap the **iPAQ Wireless** icon () in the Command bar, then tap the **Wi-Fi** icon.

If Wi-Fi is powered on, the Wi-Fi icon background turns from gray(x) to amber to green, and the Wi-Fi LED (located to the left of the power button) blinks green to indicate Wi-Fi is on.

NOTE: A blinking amber Wi-Fi LED indicates Wi-Fi is on but not connected, and a blinking green Wi-Fi LED indicates Wi-Fi is on and associated with another device.

Even though the Wi-Fi LED flashes to indicate Wi-Fi is turned on, it does not necessarily mean a connection has been established with another device or access point.

Alternatively, you can use any of the Data Connectivity icons in the Navigation bar to turn Wi-Fi on and off:

1. Tap the Data Connectivity icon in the Navigation bar.
2. When the drop-down Connectivity box displays, tap either **Turn off Wi-Fi** or **Turn on Wi-Fi**.

Battery Saving Tip: Turn Wi-Fi off when you are not using it.

Automatically Connecting to a Network

1. If one or more networks are present, the **Wi-Fi** icon () appears in the Navigation bar. Tap the network you want to connect to, then tap whether the network connects to the Internet (does not use proxy settings) or Work (uses proxy settings).

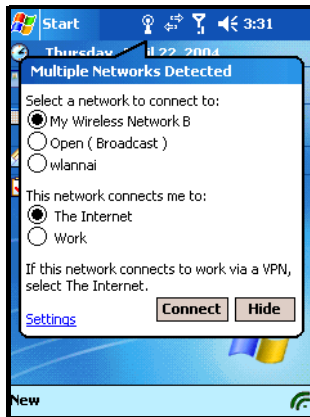

2. If you are prompted for a Network Key (WEP), enter it and tap **Connect**. If you are not sure, contact your network administrator.

Manually Entering New Network Settings

A wireless network can be added either when the network is detected (the **Wi-Fi** icon is visible in the Navigation bar) or manually by entering setting information. To manually add a wireless network:

1. From the Today screen, tap the **iPAQ Wireless** icon ().

2. On the iPAQ Wireless screen, tap the **Wi-Fi** button to turn it on, then tap the **Settings** button next to it.
3. Tap the **Wireless** tab > **Add New Settings**.
4. Tap the **General** tab and enter a network name (SSID).

NOTE: If a network was detected in step 2, the SSID is automatically entered and cannot be changed.

5. In the **Connects to:** box, select where your network connects to (**The Internet** or **Work**).
6. If you want to connect to an ad-hoc connection, tap the **This is a device-to-computer (ad-hoc) connection** checkbox.
7. If authentication information is needed, from the Settings screen, tap **Configure Wireless Networks**.

NOTE: To determine whether authentication information is needed, see your network administrator.

8. In the box next to **Authentication:**, tap the arrow for the drop-down list, and select the type of network authentication to use.
 - a. In the box next to **Data Encryption**, tap the arrow for the drop-down list, and select the type of Data encryption (**WEP enabled**) to use.
 - b. If a network key is provided by your network automatically, check the **The Key is provided for me automatically** checkbox.
 - c. To use Shared Key authentication, type the network key in the **Network Key:** box.
 - d. For increased security, check the **Enable network access using IEEE 802.1X** checkbox. You should only check this option if it is supported by your network environment. Ask your network administrator if you are unsure.

Searching for Networks to Access

Networks that you have already configured are preferred networks and are listed in **Wireless Networks**. You can choose whether to connect only to preferred networks or to have your Pocket PC search for and connect to any available network (preferred or not).

1. Turn on the Wi-Fi by tapping the **iPAQ Wireless** icon > **Wi-Fi** button > **OK**.
2. From the **Start** menu, tap **Settings** > **Connections** tab > **Connections** icon > **Advanced** tab > **Network Card** button > **Wireless** tab.
3. In the **Networks to access** box, tap the type of network you want to connect to (**All Available**, **Only access points**, or **Only computer-to-computer**).
4. To connect only to networks that have already been configured, clear the **Automatically connect to non-preferred networks** checkbox.

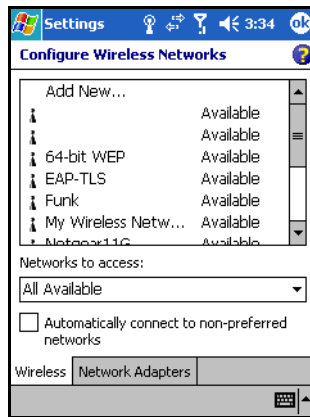

NOTE: If you check the **Automatically connect to non-preferred networks** checkbox, your Pocket PC will detect any new networks and provide you the opportunity to configure them.

Connecting to Hotspots

Connecting to a hotspot in your local coffee shop or at the airport or other public places usually requires a contract with the hotspot service provider. You can purchase a contract at the hotspot site from your service provider or by accessing the service provider's Web site.

Once you have purchased this service, you will be able to connect to their hotspots using your HP iPAQ Pocket PC.

NOTE: Some public places may even provide free hotspot connection.

To connect at the hotspot location:

1. From the **Today** screen, tap the **iPAQ Wireless** icon () in the Command bar, then tap the **Wi-Fi** icon on the iPAQ Wireless screen.

NOTE: The **Wi-Fi** icon changes to green when it is turned on and connected with another device.

2. Tap **OK**.
3. Tap the Wi-Fi icon () in the Navigation bar to view the Connectivity drop-down box.

NOTE: On some iPAQ Pocket PC models, certain hotspot networks are already preconfigured. When you turn on Wi-Fi in the presence of a preconfigured hotspot network, you are presented with a screen that requests that you enter your User Name and Password. Enter your **User Name** and **Password** and tap **OK** to connect to the hotspot network. You can save your User Name and Password and set your Pocket PC to automatically login when the hotspot network is detected in the future.

4. Select the network when it is detected and tap **Connect**.

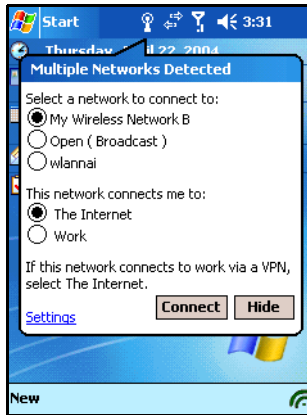

5. Launch Internet Explorer—From the **Start** menu, tap **Internet Explorer**.
6. Enter the Internet address to be accessed in the address bar and tap **GO**.

NOTE: If you experience problems connecting to the hotspot location, you will need to contact the service provider's Help line. Most hotspot locations provide brochures with Help information.

Viewing or Editing a Wireless Network

To view or edit an existing or available wireless network:

1. Tap the **Data Connectivity** icon () in the Navigation bar. When you are connected to a Wi-Fi network, the Wi-Fi Connectivity box displays the name (SSID) of the network.
2. Tap **Settings** to edit the wireless network.

You can also use the iPAQ Wireless screen to view and edit wireless connections by completing the following:

1. From the **Today** screen, tap the **iPAQ Wireless** icon in the Command bar at the bottom of the screen.

2. On the iPAQ Wireless screen, tap the **Wi-Fi** button to turn it on.
3. Tap the **Settings** button next to the Wi-Fi button, then tap the **Wireless** tab.
4. In the **Configure Wireless Networks** box, tap the desired network name.
5. Edit the existing settings as necessary, then tap **OK** to save the changes.

NOTE: You can prioritize the HP profiles by accessing the Wi-Fi settings and prioritizing the connection.

Deleting a Wireless Network

To delete an existing or available wireless network:

1. From the **Today** screen, tap the **iPAQ Wireless** icon > **Wi-Fi** button.
2. Tap the **Settings** button > **Wireless** tab.
3. In the **Configure Wireless Networks** box, tap and hold the network you want to delete.
4. From the pop-up list, tap **Remove Settings**.

Monitoring Signal Status and Strength

Wi-Fi Signal Status

To quickly determine the status of Wi-Fi connections between your Pocket PC and an access point, tap the **Data Connectivity** icon in the Navigation bar.

When you have an active connection to a Wi-Fi network, the drop-down Connectivity box displays the network name (SSID) of the network.

Wi-Fi Signal Strength

To view the signal strength between your Pocket PC and Wi-Fi access point connections:

1. Tap the **Data Connectivity** icon in the Navigation bar.
2. When the drop-down Connectivity box displays, you are able to view the name of the network the Pocket PC is connected to (SSID) and an icon displaying the signal strength.

NOTE: The **Signal Strength** icon will not be displayed if a connection is not present.



3. To make changes to the connection settings, tap **Settings**.
4. To exit the Connectivity box, tap the **Hide** button.

Working with Network Settings

Looking Up an IP Address

To find the IP address the wireless network is using:

1. Be sure Wi-Fi is powered on.
2. Connect to the appropriate network.
3. From the **Start** menu, tap **Settings** > **Connections** tab > **Connections** icon > **Advanced** tab > **Network Card** button > **Network Adapters** tab.

4. Tap the appropriate adapter to modify the settings. The IP address appears in the **IP Address** box.

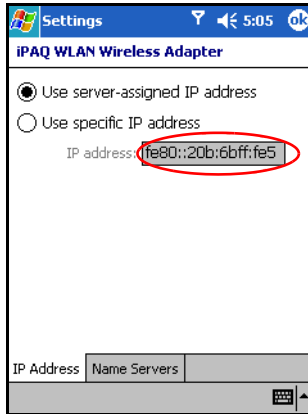

Changing TCP/IP Settings

NOTE: Most Internet Service Providers (ISPs) and private networks now use dynamically-assigned IP addresses. You will not need to change TCP/IP settings unless your ISP or private network does not use dynamically-assigned IP addresses. If you are not sure, check with your network administrator.

To change TCP/IP Settings:

1. Contact your ISP or network administrator to determine your IP address, subnet mask, and/or default gateway (if needed).
2. Be sure Wi-Fi is powered on.
3. From the **Start** menu, tap **Settings** > **Connections** tab > **Connections** icon > **Advanced** tab > **Network Card** button > **Network Adapters** tab.

4. In the **My network card connects to...** dropdown box, tap either **The Internet** or **Work**.

NOTE: If you are connecting to your ISP at home, tap **The Internet**. If you are connecting to a private network such as a corporate network at work, you should tap **Work**.

5. In the **Tap an adapter to modify settings** box, tap **iPAQ Wi-Fi Wireless Adapter**.
6. Tap the **IP Address** tab.
7. Tap **Use specific IP address** and enter the requested information.
8. Tap **OK** to save your settings.

Changing DNS and WINS Settings

NOTE: Most Internet Service Providers (ISPs) and private networks now use dynamically-assigned IP addresses. You will not need to change DNS and WINS settings unless your ISP or private network does not use dynamically-assigned IP addresses. If you are not sure, check with your network administrator.

Servers that require an assigned IP address may also require a way to map computer names to IP addresses. Your Pocket PC supports two name resolution options:

- DNS
- WINS

To change server settings:

1. Contact your ISP or network administrator to determine which name resolution to use, obtain the specific server address, and determine whether alternate addresses are available.

NOTE: An alternate address may enable you to connect when the primary server is unavailable.

2. Be sure Wi-Fi is powered on.
3. From the **Start** menu, tap **Settings** > **Connections** tab > **Connections** icon > **Advanced** tab > **Network Card** button > **Network Adapters** tab.
4. In the **My network card connects to...** dropdown box, tap either **The Internet** or **Work**.

NOTE: If you are connecting to your ISP at home, tap **The Internet**. If you are connecting to a private network such as a corporate network at work, you should tap **Work**. If a proxy server is required, you must select **Work**. For more information, refer to the section “Setting Up Proxy Server Settings.”

5. In the **Tap an adapter to modify settings** box, tap **iPAQ Wi-Fi Wireless Adapter**.
6. Tap the **Name Servers** tab and enter the requested information.
7. Tap **OK** to save your settings.

Setting Up VPN Server Connections

A VPN connection enables you to securely connect to a private or a corporate network, via the Internet. To set up a VPN server connection:

1. Contact your network administrator for your user name, password, domain name, TCP/IP settings, and host name or IP address of the VPN server.
2. Be sure Wi-Fi is powered on.
3. From the **Start** menu, tap **Settings > Connections** tab > **Connections > Tasks** tab.
4. Under **My Work Network**, tap **Add a new VPN server connection**.
5. Follow the instructions in the **New Connection** wizard.

NOTE: For online Help for any screen in the New Connection wizard or while changing settings, tap the **?**.

Changing VPN Server Connections

1. Be sure Wi-Fi is powered on.
2. From the **Start** menu, tap **Settings > Connections** tab > **Connections > Tasks** tab.
3. Under **My Work Network**, tap **Manage existing connections > VPN** tab.
4. Tap the VPN connection you want to change, then tap **Settings**.
5. In the **Name** box, enter a name for the connection (for example, your company's name).
6. In the **Host name/IP** box, enter the VPN server name or IP address.
7. Next to **VPN type**, tap the type of authentication to use with your device (**IPSec/L2TP** or **PPTP**). If you aren't sure which option to choose, ask your network administrator.

8. Tap **Next**.

NOTE: If you selected **PPTP** in the previous screen, then skip the following step.

9. If you selected **IPSec/L2TP** on the previous screen, tap the type of authentication. If you select **A pre-shared key**, enter the key provided by your network administrator, then tap **Next**.

10. Enter the user name, password, and domain name provided by your network administrator.

NOTE: If a domain name was not provided, you may be able to connect without entering one.

11. To change advanced settings, tap the **Advanced** button.

NOTE: You will not need to change advanced settings unless:

- The server to which you are connecting does not use dynamically-assigned IP addresses and you need to enter your TCP/IP settings,
or
 - You need to change server DNS or WINS settings.
-

12. Tap the **Finish** button.

Starting VPN Server Connections

To start a connection through a VPN server, be sure Wi-Fi is powered on, then select the VPN network. Your Pocket PC will automatically begin connecting.

Setting Up Proxy Server Settings

If you are connected to your ISP or private network during synchronization, your Pocket PC should download proper proxy settings from your computer. If these settings are not on your computer or need to be changed, you will need to set them up manually. To set up proxy server settings:

1. Contact your ISP or network administrator for the proxy server name, server type, port, type of Socks protocol used, and your user name and password.
2. Be sure Wi-Fi is powered on.
3. From the **Start** menu, tap **Settings > Connections** tab > **Connections > Tasks** tab.
4. Under **My Work Network**, tap **Edit my proxy server > Proxy Settings** tab.
5. Tap the **This network connects to the Internet** and **This network uses a proxy server to connect to the Internet** checkboxes.
6. In the **Proxy server** box, enter the proxy server name.
7. If you need to change port number or proxy server type settings, tap the **Advanced** button and change the desired settings.
8. Tap **OK**.

WLAN Security Protocol Utilities

Your HP iPAQ Pocket PC supports the IEEE 802.1X standard for wireless encryption for customers whose network supports this feature. Contact your company's IT Administrator to set up the following features that are installed on your Pocket PC.

TTLS

Tunnelled Transport Layer Security (TTLS) supports secure user name/password and mutual authentication. It provides highly secure transmissions allowing the client to authenticate a certificate installed on the server and then forms a secure connection between client and server. The server authenticates the client over the secured connection when the user provides a user name and password.

802.1X Certificate Enroller

This utility allows you to request a user certificate from a certificate server. Once the certificate has been received and stored on your iPAQ Pocket PC, you can access the network using one of the 802.1X protocols. Refer to “Manually Entering New Network Settings” earlier in this chapter for information on selecting one of these protocols.

To retrieve a certificate:

1. Be sure your Pocket PC has an ActiveSync connection to a computer on the same network as the certificate server.
2. Tap **Start > Settings > System tab > Certificates > Enroll**.
3. Complete the on-screen certificate request form by entering your name, password, and the server to retrieve the certificate from.
4. Tap the **Retrieve Certificate** button to download the certificate from the server. The status box at the bottom of the screen will indicate whether the attempt to retrieve the certificate was successful.

NOTE: The enrollment tool is specifically designed to interact with Microsoft Certificate Servers. Alternate Certificate Authority servers will require a custom enrollment application which can be developed using the Embedded Visual C 4.0 tool and the Software Development Kit for Windows Mobile 2003-based Pocket PCs.

LEAP Registration Utility

Cisco LEAP is an 802.1X authentication protocol that uses a username and password pair to authenticate access by a wireless client to a wireless router.

Use of the LEAP registration utility is required to log on to a LEAP-authenticated network. Most of the other types of secure networks are set up automatically by the iPAQ Wi-Fi connection software. However, accessing a LEAP-authenticated network requires initial registration using this utility. Once you have authenticated and accessed this type of network, a connection can take place automatically whenever you access the LEAP-authenticated network.

To register the LEAP utility:

1. Tap **Start > Settings > System tab > LEAP.**
2. Tap **New** to create a LEAP profile. A LEAP profile must contain the following information:
 - SSID
 - Username
 - Password
 - Domain
 - Authentication type required by the LEAP server
3. Tap **Modify** to make changes to the selected LEAP profile from the Wireless LEAP list. Changes to the LEAP profile can also be made by tapping on an entry in the Wireless LEAP list.
4. Tap **Delete** to delete the selected LEAP profile from the Wireless LEAP list.

Using Bluetooth

Your HP iPAQ Pocket PC comes with built-in Bluetooth technology that allows short-range connections and provides fast, reliable, wireless communication.

With Bluetooth powered on, you can send information or perform the following tasks wirelessly between two Bluetooth devices, within a range of approximately 30 feet (10 meters):

- Exchange contacts, calendar items, and tasks
- Send or exchange business cards
- Transfer files
- Synchronize with a computer through an ActiveSync connection
- Partner with a Bluetooth-enabled cell phone and use the cell phone as a wireless modem
- Partner with a Bluetooth-enabled portable notebook and use your iPAQ Pocket PC as a wireless modem
- Connect to other Bluetooth devices (Virtual COM port)
- Print to a Bluetooth printer
- Use a Bluetooth headset

- Create a personal area network (PAN) to chat, play games, etc.

NOTE: Use of dial-up and wireless Internet, e-mail, corporate networks, and other wireless communications, such as Bluetooth-enabled devices, may require separately purchased additional hardware and other compatible equipment, in addition to a standard Wireless Local Area Network (WLAN) or Wi-Fi infrastructure and a separately purchased service contract. Check with your service provider for availability and coverage in your area. Not all Web content may be available. Some Web sites may not be formatted to fit Pocket PC screens and may require installation of additional software.

Getting Acquainted with Bluetooth

Before you start using Bluetooth to establish wireless connections, take a few minutes and familiarize yourself with:

- Terms used in this chapter
- Supported Services
- Bluetooth Settings
- Bluetooth Manager

NOTE: For more detailed help, refer to the Help files installed on your Pocket PC. From the **Start** menu, tap **Help > Bluetooth**.

Understanding Terms

The following Bluetooth terms are used throughout this chapter.

Term	Definition
Authentication	Verification of a numeric passkey before a connection or activity can be completed.
Authorization	Approval of a connection or activity before it can be completed.
Bonding (Paired devices)	Creating a trusted connection between your device and another. After a bond is created, the two devices become paired. A paired device does not require authentication or authorization.
Device address	Unique electronic address of a Bluetooth device.
Device discovery	Location and recognition of another Bluetooth device.
Device name	Name that a Bluetooth device provides when discovered by another device.
Encryption	Method of protecting data.
Passkey	Code you enter to authenticate connections or activities requested by other devices.
Personal Information Manager (PIM)	Collection of programs used to manage daily business tasks (for example: Contacts, Calendar, and Tasks).
Profiles	Collection of Bluetooth settings.
Service discovery	Determination of which programs you have in common with other devices.

Supported Services

The functions that Bluetooth supports are called services. You can communicate only with Bluetooth devices that support at least one of the following service profiles:

- BPP (Basic Printer profile)
- DUN (Dial-up Networking profile)
- FAX
- FTP (File Transfer profile)
- GAP (Generic Access profile)
- HCRP (Hard Cable Replacement profile)
- HSP (Headset profile)
- LAP (LAN Access profile)
- OBEX (Object Exchange profile)
- OPP (Object Push profile)
- PAN (Personal Area Network profile)
- SPP (Serial Port profile)
- ActiveSync (Uses SPP to connect to ActiveSync on a computer)

Working with Bluetooth Settings

From the tabs in **Bluetooth Settings**, you can:

- Select or add a user profile
- Turn Bluetooth on and off
- Enter or change your Pocket PC Bluetooth Identification
- Set your connection preferences
- Enable Bluetooth services
- Specify security settings

- Define settings for sharing and connecting
- View software and port information

Turning On Bluetooth

To turn on Bluetooth:

1. From the **Today** screen, tap the **iPAQ Wireless** icon.
2. On the iPAQ Wireless screen, tap the **Bluetooth** icon.

When Bluetooth is turned on, the **Bluetooth** LED on the top of your Pocket PC blinks blue.

To turn off Bluetooth, tap the **Bluetooth** icon again. When Bluetooth is turned off, the Bluetooth LED stops blinking and no incoming or outgoing Bluetooth connections are possible.

Battery Saving Tip: Turn Bluetooth off when you are not using it.

Opening Bluetooth Settings

1. From the **Today** screen, tap the **iPAQ Wireless** icon in the Command bar.
2. On the iPAQ Wireless screen, tap **Bluetooth > Settings**.

NOTE: Bluetooth must be powered on to enable the Bluetooth Settings button. You cannot access the settings if you press the Bluetooth Settings button while in a disabled state. For this reason, tapping the Bluetooth button is included in all following instructions. Tapping the Bluetooth button when it is already on turns it off.

Setting Accessibility Properties

Before your Pocket PC interacts with other Bluetooth devices, you need to enter or change the accessibility properties to define how you want your Pocket PC to interact.

To display the Accessibility screen:

1. From the **Today** screen, tap the **iPAQ Wireless** icon in the Command bar.
2. On the iPAQ Wireless Screen, tap **Bluetooth > Settings > Accessibility** tab.
3. Highlight the name in the **Name** field and enter your new Device Identification name. The device name is what other devices see on their screen when they locate your device.
4. Select **Allow other devices to connect**.
5. Select either **All devices** or **Paired devices only**.



CAUTION: Selecting **All devices** allows any device, even those unknown to you, to connect to your Pocket PC. After they are connected, security settings for specific services apply as specified in the Bluetooth Settings. Selecting **Paired devices only** allows only devices that you trust to connect to your Pocket PC.

NOTE: Paired devices share and exchange an internally generated secure Link Key before connecting.

6. Select **Other devices can discover me** if you want to allow other devices to search and locate your Pocket PC. Otherwise, leave this box unchecked.

NOTE: If another device has your device's address and you have selected **Other devices can discover me**, that device may be able to locate and connect to your device even though you did not select for it to be discovered.

7. Tap **OK** to save your changes.

Enabling Bluetooth Services

You can use any of the following security options when transferring files, creating a serial port connection, exchanging business card information, configuring dial-up networking, and joining a personal network.

Automatically Enabling Services

To automatically enable services:

1. From the **Today** screen, tap the **iPAQ Wireless** icon in the Command bar.
2. Tap **Bluetooth > Settings > Services** tab.
3. In the **Services** box, select the service you want to enable: **File Transfer, Information Exchange, Serial Port, Personal Network Server, Hands free, or Dial-up Networking Server.**

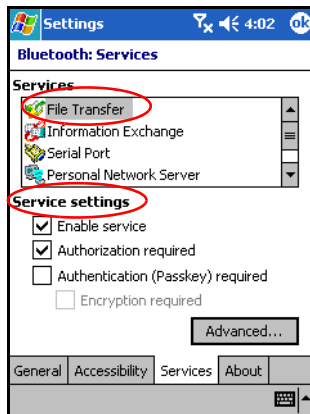

4. The **Service** you select automatically enables the **Service settings**. Tap on the appropriate checkbox to change these Service settings to your preference.
5. Tap **OK** to return to the iPAQ Wireless Screen.

NOTE: If you select **Authorization required** in the Service Settings, you must authorize each connection. Your Pocket PC will then always ask you if the connection should be permitted.

Secure Connections using a Passkey or Bond

To establish a secure connection with another device, you can use the passkey feature or an established bond. You can also add data encryption to this type of security.

A passkey is a code you enter to authenticate connections requested by other devices. The passkey must be known and used by both parties or the connection will not be allowed.

To require a passkey or bond:

1. From the **Today** screen, tap **iPAQ Wireless > Bluetooth > Settings > Services** tab.
2. Tap the tab for the service you want to enable: **File Transfer, Information Exchange, Serial Port, Personal Network Server, Hands free, or Dial-up Networking Server**.
3. Select **Authentication (Passkey) required**.
4. Select **Encryption Required** if you want to require all data exchanged between the devices to be encrypted.
5. Tap **OK**.

Setting a Shared Folder

You can determine the folder that other devices access when they connect to your Pocket PC.

To select a shared folder:

1. From the **Today** screen, tap the **iPAQ Wireless** icon > **Bluetooth > Settings > Services** tab.
2. Under **Services**, tap **File Transfer**.
3. Under **Service Settings**, select your preferred settings.
4. Tap the **Advanced** tab.

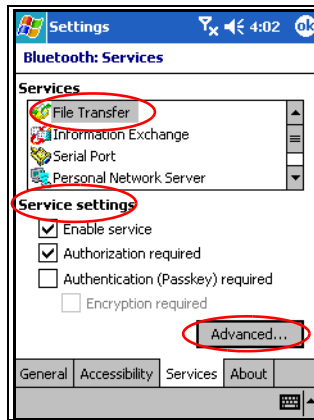

5. Tap the **Folder** icon and locate a desired file folder.
6. Tap **OK**.

Understanding Profiles

Use profiles to quickly enable selected personal settings in multiple environments.

Creating a Profile

To create a profile:

1. From the **Today** screen, tap the **iPAQ Wireless** icon in the Command bar
2. Tap **Bluetooth** > **Settings** > **General** tab > **Profile** icon.

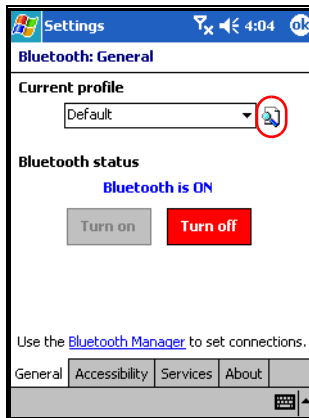

3. Tap the **New** button.
4. Enter a descriptive name.
5. Select an existing profile to use as a template.
6. Tap **OK**.

Activating a Profile

When a new profile is created, you must activate it to function as the current profile.

To activate a profile after creating it:

1. From the **Today** screen, tap the **iPAQ Wireless** icon in the Command bar > **Bluetooth** > **Settings**.
2. From the **General** tab, select it from the **Current Profile** down arrow list.
3. Tap **OK**.

Saving Bluetooth Configuration Settings in a Profile

To save the Pocket PC Bluetooth configuration settings to any profile:

1. From the **Today** screen, tap the **iPAQ Wireless** icon in the Command bar > **Bluetooth** > **Settings**.
2. From the **General** tab, tap the **Profile** icon.
3. Select a profile from the **Add/Delete Profiles** list or create a new one.
4. Tap **OK**.
5. Tap the **Services** tab and specify the desired connection, sharing, and security settings in all Bluetooth **Services** selections.
6. Tap **OK** to save the changes and close **Bluetooth Services**.

Renaming a Profile

1. From the **Today** screen, tap the **iPAQ Wireless** icon in the Command bar > **Bluetooth** > **Settings**.
2. From the **General** tab, tap the **Profile** icon.
3. Select a profile from the **Add/Delete Profiles** list.
4. Tap the **Rename** button.
5. Enter a new descriptive name.
6. Tap **OK**.

Deleting a Profile

1. From the **Today** screen, tap the **iPAQ Wireless** icon > **Bluetooth** > **Settings**.
2. From the **General** tab, tap the **Profile** icon.
3. Select a profile from the **Add/Delete Profiles** list.
4. Tap the **Delete** button.
5. Tap **Yes** to confirm you want to delete the profile.
6. Tap **OK**.

Working with Bluetooth Manager

Use Bluetooth Manager to:

- Establish connections
- Exchange business cards
- Control the on-screen display
- Display shortcuts

Opening Bluetooth Manager

From the **Today** screen, tap the **iPAQ Wireless** icon in the Command bar > **Bluetooth** > **Manager**.

The first screen that displays is **My Shortcuts**.

NOTE: Bluetooth must be powered on to enable the Bluetooth Manager button. You cannot access Manager if you press the Manager button while in a disabled state. For this reason, tapping the Bluetooth power-on button is included in all following instructions. If Bluetooth is already powered on when you perform the tasks, do not tap the Bluetooth button again. Tapping the Bluetooth button when it is already on turns it off.

Locating and Selecting a Device

Several tasks require you to locate a device and connect to it.

When you are required to locate a device, the Bluetooth browser assists by searching for your desired function that supports other Bluetooth devices.

Pairing Devices

You can pair devices so they must exchange a computer generated security key prior to each connection. The security key is generated from a unique Bluetooth device address, a random number, and a user-defined password.

After two devices are paired, they have a trusted relationship with each other. No additional input is needed from the user. Therefore, connections and activities can be performed between the paired devices without constant authorization from the user.

To pair devices:

1. From the **Today** screen, tap the **iPAQ Wireless** icon in the Command bar > **Bluetooth > Manager**.
2. Tap **Tools > Paired devices**.
3. Tap **Add**.
4. Tap the **Lookup**  icon.
5. Tap a device.
6. Enter a password in the **Passkey** field.
7. Tap **OK**.
8. Enter the same password into the other device.

NOTE: Some devices, such as mobile phones, need to be placed in a mode to accept a bond from another device. Refer to that device's user instructions for more information.

Unpairing Devices

You can remove a paired relationship between devices.

1. From the **Today** screen, tap the **iPAQ Wireless** icon in the Command bar > **Bluetooth > Manager**.
2. Tap **Tools > Paired devices**.
3. Tap a device name.
4. Tap **Remove**.
5. Tap **Yes** to remove the pairing.

Connecting to Other Devices

Use ActiveSync, serial and dial-up connections to communicate with other Bluetooth devices. Establish a partnership with a cell phone and set up the Bluetooth services it offers.

Identifying the Communications Port

You can identify the virtual COM ports used to create a **serial port** connection. You may need to identify these COM ports for activities such as printing.

Use the inbound COM port when other devices initiate a serial connection. Use the outbound COM port when you initiate a serial connection to another device.

To identify the communications port:

1. From the **Today** screen, tap **iPAQ Wireless > Bluetooth > Settings > Services** tab.
2. Under Services, tap **Serial Port** and tap the **Advanced...** button.
3. Note the names of your inbound and outbound COM ports.
4. Tap **OK**.

Establishing a Headset Connection

You can redirect your iPAQ Pocket PC's audio to a headset or use a headset's microphone with your Pocket PC.

To establish a headset connection:

1. From the **Today** screen, tap **iPAQ Wireless > Bluetooth > Manager**.
2. Tap **New > Hands-free/Headset setup > Next**.
3. Follow the connection wizard instructions.

Establishing an ActiveSync Connection

You can set up an ActiveSync partnership with a Bluetooth-enabled computer by first setting up your computer, then setting up your Pocket PC.

If you own an HP Evo Notebook or Desktop computer, you can use the Bluetooth Multiport Module presinstalled on that computer with your Pocket PC.

If you are using other Bluetooth modules or cards on your computer, refer to the Bluetooth Configuration Manager or Settings for similar setup procedures, then skip to [“Setting Up an ActiveSync Partnership on Your Pocket PC.”](#)

Using the HP Bluetooth Multiport Module for Evo Notebooks and Desktops

1. Remove your Pocket PC from the USB Synchronization Cradle.
2. Turn on Bluetooth on both the Pocket PC and the Evo computer.
3. Right-click the Bluetooth icon in the system tray on your computer, then click **Advanced Configuration**.
4. Select the **Client Applications** tab, then write down the COM port number listed next to **Bluetooth Serial Port**.

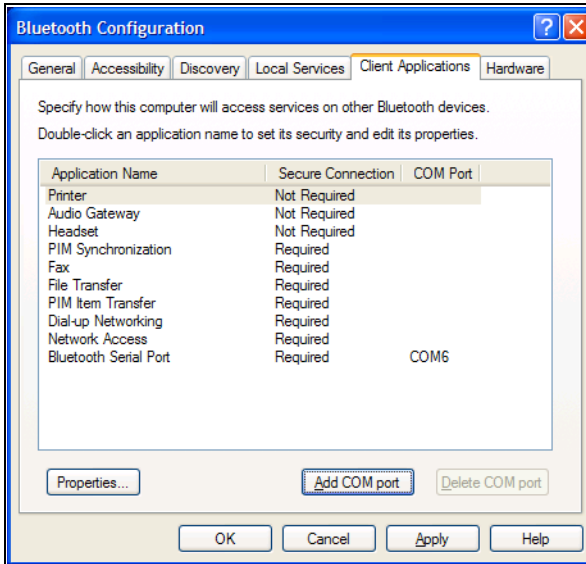

5. Select **Bluetooth Serial Port**, then click on the **Delete COM Port** button.
6. Click on the **Local Services** tab, then click **Add Serial Service**.
7. Type a name for the serial service, then select **Startup Automatically**.
8. Remove the checkmark from the **Secure Connection** box, then select the COM port that is the same as the one you wrote down earlier. Click **Apply** > **OK** > **OK**.

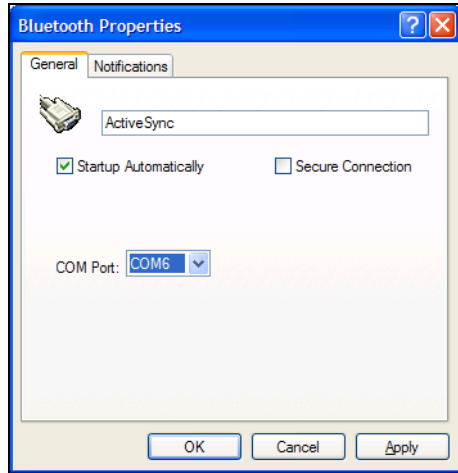

9. Open ActiveSync on your computer, then click **File > Connection Settings**.
10. Check the **Allow Serial Cable or Infrared Connection to this COM Port** box.
11. Select the COM port that is the same as the one you wrote down earlier, then click **OK**.

Setting Up an ActiveSync Partnership on Your Pocket PC

To establish an ActiveSync connection:

1. From the **Today** screen, tap **iPAQ Wireless > Bluetooth > Manager**.
2. Tap **New > ActiveSync via Bluetooth > Next**.

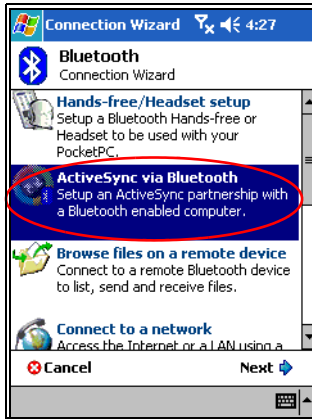

3. Follow the connection wizard instructions.

NOTE: Be sure the ActiveSync COM port setting on your Pocket PC is the same as the COM port setting used for Bluetooth on your computer.

4. From the **Bluetooth Browser** screen, select the computer you want to synchronize with. Tap **Next**.

- Under **Serial Port Selection**, select the name of the serial port for the computer selected above, then tap **Next > Finish**.

NOTE: If you are setting up the ActiveSync partnership with an Evo Notebook or Desktop computer, select the name you typed in Step 7 of “Using the HP Bluetooth Multiport Module for Evo Notebooks and Desktops.”



Establishing a Serial Connection

Use the wireless Bluetooth serial port connection just as you would a physical serial cable connection. You must configure the application that will use the connection to the correct serial port.

To establish a serial connection:

- From the **Today** screen, tap the **iPAQ Wireless** icon > **Bluetooth > Manager**.
- Tap **New > Explore a Bluetooth device > Next**.
- Follow the connection wizard instructions.

Dial-Up Networking Service

Use dial-up networking (DUN) to connect to the internet from another Bluetooth device through your iPAQ Pocket PC.

Using Dial-Up Networking Service

NOTE: An activated SIM card must be inserted in your Pocket PC and the phone must be turned on before beginning this process.

To connect to a device that provides phone or modem access:

1. You must first pair the two devices. For more information, see the section on [“Pairing Devices”](#) in this chapter.

On the Alternate device:

2. Use the documentation that came with the alternate device to create a connection to the HP iPAQ Pocket PC h6300 Series.
 3. On the screen that requires you to enter a phone number, use *99#. You may need to enter the country code and area code, depending on where you are calling.
-

NOTE: To use the HP iPAQ Pocket PC h6300 Series as a dial-up networking server, use the default phone number *99#.

Depending on your location, you may not need the country code or area code. For more information on this, refer to your mobile phone service provider.

4. Tap **OK** to begin dialing.

On your iPAQ Pocket PC h6300 Series:

5. On the **Bluetooth > Manager > My Shortcuts** screen, a connection dialog box briefly displays, then the network logon screen displays. To authorize the dial-up connection, tap **Accept**.

On the Alternate device:

6. A settings box displays your device dialing *99#. On the **Bluetooth My Shortcuts** screen, you will see an icon with two green arrows pointing toward each other to indicate a connection has occurred. You can now connect to the internet.

NOTE: After you create the dial-up networking shortcut with a device, tap and hold the Dial-up Networking icon in the **My Shortcuts** tab of **Bluetooth Manager**, and tap **Connect**.

Joining a Personal Area Network

Connect two or more Bluetooth devices to share files, collaborate or play multiplayer games.

To establish a Personal Area Network connection:

1. From the **Today** screen, tap **iPAQ Wireless > Bluetooth > Manager**.
2. Tap **New > Join a personal network > Next**.
3. Follow the Connection Wizard instructions.

Working with Files

You can exchange information with a connected device and use the Bluetooth File Explorer to:

- Navigate through the directories.
- View files and folders.
- Create new folders.
- Send and receive files from a remote device.
- Delete and rename files on a remote device.

Creating a File Transfer Connection

1. From the **Today** screen, tap **iPAQ Wireless > Bluetooth > Manager**.

The first screen that displays is **My Shortcuts**.

2. Tap **New > Browse files on a remote device > Next**.
3. Follow the connection wizard instructions.

NOTE: The remote device must have Bluetooth turned on and set up to allow discovery before the connection can occur.

Sending Files

1. Tap and hold the file transfer shortcut icon, and tap **Connect**.
2. Tap **File > Send a File...**
3. Locate the file(s) to send.
4. Tap the file(s) to send it.
5. Tap **OK**.

Creating a Folder on a Remote Device

1. Tap and hold the file transfer shortcut icon, and tap **Connect**.
2. Navigate to the location you want for the new folder.
3. Tap **File > Create a folder**.
4. Enter a folder name while **New Folder** is selected, and tap **Enter**.
5. Tap **OK**.

Receiving a File from a Remote Device

1. Tap and hold a file transfer shortcut icon, and tap **Connect**.
2. Navigate to the file location on the remote device.
3. Tap the file.
4. Tap **File > Get**.

5. Tap **OK**.

Deleting a File from a Remote Device

1. Tap and hold a file transfer shortcut icon, and tap **Connect**.
2. Navigate to the file location on the remote device.
3. Tap the file.
4. Tap **File > Delete**.
5. Tap **Yes** to verify you want to delete the selected file.
6. Tap **OK**.

Using Business Card Exchange

Using the business card exchange, you can:

- Set up your own business card
- Send a business card to one or more devices
- Request a business card from one or more devices
- Exchange business cards with one or more devices

You must establish a default contact name to send or exchange business card information.

You must first specify your default business card on the **Information Exchange** tab in **Bluetooth Settings**. This name becomes the default for business card transfers.

Setting Up Your Business Card Information

To set up your business card information:

1. Create a contact in the **Contacts** program that includes your name, title, and other relevant information.
2. From the **Today** screen, tap **iPAQ Wireless > Bluetooth > Settings > Services** tab.
3. Under Services, select **Information Exchange**.
4. Tap the **Advanced...** button.

5. Tap the **My business card (vCard)** icon.

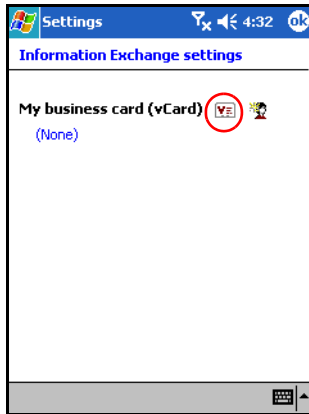

6. Select your contact from the Contacts list.
7. Tap **OK**.

NOTE: To create a new business card, tap the **Contacts** icon next to the vCard icon and create a new business card. Tap **OK** when you are finished.

Sending Business Cards

1. From the **Today** screen, tap the **iPAQ Wireless** icon in the Command bar > **Bluetooth** > **Manager**.
2. Tap **Tools** > **Business Card Exchange**.



3. Tap the **Send** icon.
4. Tap the device where you want to send your business card.
5. Tap **OK**.

NOTE: Be sure the receiving device has been enabled to accept the transfer.

Requesting Business Cards

1. From the **Today** screen, tap the **iPAQ Wireless** icon in the Command bar > **Bluetooth** > **Manager**.
2. Tap **Tools** > **Business Card Exchange**.
3. Tap the **Request** icon.
4. Tap the device from which you want to request a business card.
5. Tap **OK**.

Exchanging Business Cards

You can exchange business card information with another device. If available, the device's information will be sent directly into your **Contacts** list in **Pocket Outlook**.

To exchange business cards:

1. From the **Today** screen, tap the **iPAQ Wireless** icon in the Command bar > **Bluetooth** > **Manager**.
2. Tap **Tools** > **Business Card Exchange**.
3. Tap the **Exchange** icon.
4. Tap the device with which you want to exchange your business card.
5. Tap **OK**.

Opening a Connection

1. From the **Today** screen, tap the **iPAQ Wireless** icon in the Command bar > **Bluetooth** > **Manager**.
2. Tap **New** > **Explore a Bluetooth Device** and allow the discovery process to search for the Bluetooth enabled device.
3. When the discovered device icon displays on your screen, tap and hold the discovered device icon or list name, and tap **Connect**.
4. Tap **OK**.

NOTE: Bluetooth can be set to automatically open a connection by setting your connection preferences. For more information, refer to Chapter 6, "Making Your Data Connections."

Viewing Connection Status

You can view:

- Connection's name

- Device's name
- Connection status
- Length of connection
- Signal strength

To view the connection status:

1. From the **Today** screen, tap the **iPAQ Wireless** icon in the Command bar > **Bluetooth** > **Manager**.
2. Tap and hold an active connection icon or list name, and tap **Status**.
3. Tap **OK**.

Closing a Connection

1. From the **Today** screen, tap the **iPAQ Wireless** icon in the Command bar > **Bluetooth** > **Manager**.
2. Tap and hold the connection icon or list name.
3. Tap **Disconnect** from the menu.
4. Tap **OK**.

Viewing Connection Information

1. From the **Today** screen, tap the **iPAQ Wireless** icon in the Command bar > **Bluetooth** > **Manager**.
2. Tap and hold the connection icon or list name.
3. Tap **Properties** from the menu.
4. Tap **OK**.

Working with Connections

You can create shortcuts to open and view status information for all connections.

Creating a Shortcut

Creating a shortcut to one or more services does not establish a connection. It only places a shortcut to that service on the **Shortcut** tab of the **Bluetooth Manager**.

To create a shortcut:

1. From the **Today** screen, tap the **iPAQ Wireless** icon in the Command bar > **Bluetooth > Manager**.
2. Tap **New**, then a type of service, and tap **Next**.
3. Follow the connection wizard instructions.

NOTE: Paired devices are designated by a checkmark.

Deleting a Shortcut

1. From the **Today** screen, tap the **iPAQ Wireless** icon > **Bluetooth > Manager**.
2. Tap and hold the connection icon or list name to be deleted.
3. Tap **Delete** from the menu.
4. Tap **Yes** to verify the selected shortcut should be deleted.
5. Tap **OK**.

Viewing Shortcuts

You can view shortcuts as icons or in a list format.

1. From the **Today** screen, tap the **iPAQ Wireless** icon > **Bluetooth > Manager**.
2. Tap **View**.
3. Tap **List** or **Icon**.
4. Tap **OK**.

Using the Camera Features

NOTE: Camera features are included on certain iPAQ h6300 Series models.

The camera features of the HP iPAQ Pocket PC allow you to turn your HP iPAQ Pocket PC into a mobile digital imaging center. You can share images through e-mail or the Web, or print from your iPAQ Pocket PC using Bluetooth.

The software programs described below are included on your HP iPAQ Pocket PC or on the Companion CD.

HP Camera Software	Function
HP Image Capture	Take digital photographs and modify settings with your HP iPAQ Pocket PC Camera.
HP Image Zone	Display individual images and run slideshows on your Pocket PC. Also print, send, record and email images directly from your Pocket PC to share with friends and family.
HP Image Transfer	Transfer digital images from the Pocket PC to your personal computer. This software is included on the Companion CD and must be downloaded before you can use it.

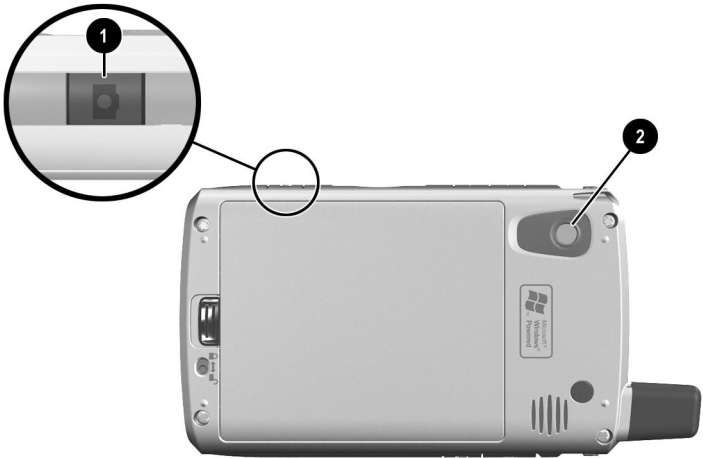

Camera Components







The iPAQ Pocket PC includes a camera shutter button **1** on the side, and a camera lens **2** on the back.



Taking a Picture

When you launch HP Image Capture, the following camera icons display on the screen.

HP Image Capture Icons	Definition
	Tap to exit the HP Image Capture application.
	Tap for Help.
	Tap to access the Camera menu.

HP Image Capture Icons	Definition (<i>Continued</i>)
	Tap to review images.
	Tap to zoom out or press the bottom side of the Navigation button.
	Tap to zoom in or press the top side of the Navigation button.
	Press or tap the Camera Shutter to snap a picture.

To take a picture:

1. From the **Start** menu, tap **Programs > HP Image Capture**.
2. Locate the camera lens on the back of the Pocket PC and frame the subject to be photographed in the digital viewfinder on the Pocket PC screen.
3. Tap the  icon to zoom in on the subject, or tap the  icon to zoom out.

NOTE: You can also press the top side of the Navigation button to zoom in, or press the bottom side of the Navigation button to zoom out. Pressing the Navigation button in the middle will snap a picture.
4. Make sure that both you and your subject do not move to ensure a clear image.
5. Press the **Shutter button** on the side of the Pocket PC or press the **Shutter** icon () on the screen to snap a picture.

Tip: You can also take pictures by pressing down on the middle of the Navigation button. Use the mode that is convenient for you.

When you snap a picture, your iPAQ Pocket PC makes an audible shutter sound (if you have not muted the sounds). The clock runs to indicate that the picture has been taken and your iPAQ Pocket PC is processing the picture. It may take a few seconds to process and store the picture, depending on its size, quality, and complexity.

Immediately after capturing an image a preview of the picture you just took appears so that you can decide to either discard, e-mail, or keep the image.

- To discard the image, tap on the **Trash** button on the screen while the preview image is being displayed.
- To e-mail the image, tap on the **E-mail** button on the screen:
 1. Enter the appropriate e-mail address or tap the **Contacts** icon on the **To:** line and select the appropriate Contact name.
 2. Enter the subject and/or message if any and, when finished, tap **Send**.

NOTE: Notice that the attached image appears at the bottom of the e-mail message.

- To save an image, tap **OK** or simply wait for the preview to disappear from the screen and the camera application to return to the digital viewfinder.

Ending Your Photo Session

- To exit the camera application, tap the **Close** button  on the screen.

NOTE: The **X** in the top right corner looks like a Close button, but actually only minimizes the camera application, and it continues to run in the background.

Adjusting the Camera Settings

Besides simple “point-and-shoot” photography, your HP Pocket PC Camera includes many other features such as:

- Exposure settings (white balance, auto-exposure metering)
- Color settings
- Compression settings
- Resolution settings
- Self-timer

To make changes to the camera settings:

1. From the **Start** menu, tap **Programs > HP Image Capture**.
2. Tap the menu icon (.
3. Select the category that you would like to modify from the **Settings** tab or the **Setup** tab, then tap **Change**.
4. Choose the best setting from the list of options.
5. Tap **OK** to exit the Settings menu.

White Balance

To adjust the color balance in the image (depending on the lighting conditions), select from the following settings:

- **Auto** (default)—Automatically selects the best white balance for the shot.
- **Sun**—Best for outdoor shots with natural lighting (sunny or cloudy conditions).
- **Tungsten**—Best for indoor shots using incandescent lighting.
- **Fluorescent**—Best for shots taken with fluorescent lighting.
- **None**—Best for shots where one color (other than white) is prevalent in the picture.

Color

Select from the following color settings to capture images with creative effects:

- Full Color (default)—Standard color output.
- Black & White—Grayscale images.
- Sepia—Brown & White for old-fashioned images.
- Negative—Produces a color negative of the image taken.
- Cool—Blue & White images.

Compression

Choose the picture quality from three compressions for the pictures you snap. Higher-quality pictures look better, especially at greater magnification. Lower-quality pictures require less storage space on your iPAQ Pocket PC, and may take less time when sending by e-mail or infrared.

- Good—Smallest file size
- Better (default)—Medium file size
- Best—Largest file size

Resolution

Choose from three resolutions or sizes of pictures. Larger resolution size pictures require more storage space and may also take longer to process and send.

- 640 x 480 pixels (default)
- 320 x 240 pixels
- 160 x 120 pixels

Exposure Mode

Choose from the following Exposure Modes to determine the shutter speed:

- Auto—Use for still photographs
- Action—Use for changing or moving photographs

Setting Up Other Features

Camera Sounds

Camera Sounds allows you to turn on or off any sounds made when buttons are pressed.

1. From camera mode, tap  > **Setup** tab.
2. Tap **Camera Sounds**, then tap **Change**.
3. Tap **Off** to turn off the sounds, or tap **On** to turn on the sounds.
4. Tap **OK** to exit the Settings menu.

Configuring Instant Review

Instant Review allows you to see a preview of the image you just captured to quickly determine whether you want to keep or discard the image.

To set the time period for Instant Review:

1. From camera mode, tap  > **Setup** tab.
2. Select **Instant Review** from the list, then tap **Change**.
3. Select the period of time you want the Instant Review image to remain on the screen.
4. Tap **OK** to exit the Settings menu.

Using the Self-Timer

The Self-Timer allows you to set a short delay before a picture is snapped. Use this feature when you want to be in your own pictures.

To set the timer:

1. From camera mode, tap  > **Setup** tab.
2. Select **Self-Timer** from the list, then tap **Change**.
3. Select a delay of either 2 or 10 seconds by selecting the corresponding option on the menu.
4. Tap **OK** to exit the Settings menu.

To cancel the timer:

1. Tap  > **Setup** tab.
2. Select **Self-Timer** from the list, then tap **Change**.
3. Select **Off**.
4. Tap **OK** to exit the Settings menu.

Configuring File Settings

The file settings menu allows you to specify how images are named and stored on your iPAQ Pocket PC. Using the File tab settings, you can change the filename prefix of images you capture and adjust the image counter. Additionally, you can specify the folder on your iPAQ Pocket PC where images are stored.

To access the file settings menu:

1. From camera mode, tap  > **File** tab.
2. Make the desired changes to the file configuration.
3. Tap **OK** to exit the **Settings** menu.

Using HP Image Zone

NOTE: By default, HP Image Zone displays images that are saved in the My Documents folder on your Pocket PC.

Use HP Image Zone (for the Pocket PC) to:

- View pictures stored on your Pocket PC or on a storage card
 - Record sounds with pictures
 - View a slideshow
 - Print pictures
-

NOTE: You can find more information on using HP Image Zone in the Help files. Tap **Start > Programs > HP Image Zone**, then tap  > **Help**.

Viewing Pictures

1. From the **Start** menu, tap **Programs > HP Image Zone**.
-

NOTE: The viewer opens in Browse mode by default. Browse mode displays a thumbnail view of the pictures in the current folder.

2. Tap a thumbnail to select the picture. A preview of the picture and information about it will be displayed.

To view images in a different folder:

1. Tap **File > Change Folder**.
2. Select the desired folder.
3. Tap **OK**.

Viewing a Picture Full-Screen

To view a picture full-screen, and to be able to zoom in or out:

1. Select the picture by tapping on its thumbnail.
2. Tap **View > Image**, or tap on the preview window.
3. Zoom in or out using the toolbar buttons. If the picture is too large to fit on the screen, you can display other parts of the picture by dragging the stylus on the screen, or by using the Navigation Buttons.

Recording Sound With a Picture

You can record sound for each picture. When the picture is displayed, the associated sound is played. Pictures with sound have a speaker icon in their thumbnails.

To add sound to a picture:

1. Select the picture by tapping on its thumbnail.
2. Tap the **Cassette** icon on the menu bar.
3. Tap the **Record** button on the **Recording** toolbar.
4. Speak into the microphone or record the sound.
5. Tap the **Stop** button on the **Recording** toolbar.

To change audio options:

1. Tap **File > Options > Audio** tab.
2. Select your audio options.
3. Tap **OK**.

Viewing a Slideshow

You can view a slideshow of the images in the current folder. To start the slideshow, tap **View > Slideshow**.

During the slideshow, tap anywhere on the screen to display the on-screen controls which you can use to move forward or backward through the slides, or to end the slideshow. You can also use the Navigation Buttons to move forward or backward through the slides.

You can control display options such as:

- Sequence
- Delay
- Rotation
- Transition Effect

To change slideshow settings:

1. Tap **File > Options > Slideshow** tab.
2. Select the settings and effects you want to use in your slideshow.
3. Tap **OK**.

Printing Pictures

You can print pictures from HP Image Zone if HP Mobile Printing has been installed from the Companion CD, or you can use Bluetooth to print your images if you have access to a Bluetooth-enabled printer.

To print a picture:

1. Select the picture to be printed by tapping on its thumbnail.
2. Tap **File > Print**.

NOTE: For more information on using HP Image Zone, tap **Start > Programs > HP Image Zone**, then tap  **> Help**.

E-mailing a Picture

You can e-mail pictures directly from HP Image Zone without opening Inbox. To e-mail a picture from HP Image Zone:

1. Tap the thumbnail of the image to be e-mailed.
2. Tap **File > Send > via E-mail** and enter the appropriate e-mail address or tap the **Contacts** icon in the Navigation bar and select the appropriate Contact name.

NOTE: Notice that the attached image appears at the bottom of the e-mail message.

3. Enter the subject and/or message if any, and, when finished, tap **Send**.

Exiting HP Image Zone

- To exit from HP Image Zone, from the Command Bar, tap **File > Exit**, or tap the **X** in the upper right corner of the screen.

Tips for Taking Better Pictures

There are a number of things you can do to ensure the pictures you take with your HP Image Capture Camera are of the highest possible quality.

- When taking pictures of scenes with many fine details and many colors (for example, a farmer's market), use the **Best** compression setting.
- When taking pictures of subjects where the background has bright lights, try to frame the subject so that the bright lights do not appear in the picture.
- Change the White Balance setting to the appropriate type of lighting, or choose **None** under the following conditions:

- ❑ Pictures taken with indoor lighting appear tinted (either bluish or yellowish).
- ❑ The picture is composed of a uniform, primary color (for example, a close-up shot of lemons or oranges).
- ❑ No white color is present in picture.

Expansion Cards

You can expand the memory and connectivity of your Pocket PC by using SD (Secure Digital), SDIO (Secure Digital IO), or MMC (Multimedia Memory) expansion cards. Use these optional expansion cards for:

- Adding functionality such as the HP PhotoSmart Mobile Camera, Bar Code Scanners, etc.
- Expanding the memory of your Pocket PC for data storage
- Viewing the content of memory cards (SD/MMC)

NOTE: Expansion cards must be purchased separately and are not included with your Pocket PC.

To locate information about expansion cards, go to the following HP Web site: www.hp.com/Go/ipaqaccessories.

Installing a Secure Digital (SD) Expansion Card

To install a Secure Digital (SD) card into the expansion slot on the Pocket PC:

1. Locate the slot on the right side of the Pocket PC.
2. Insert the expansion card into the expansion slot and push the connection edge of the card firmly into the expansion slot.

NOTE: Be sure the expansion card label is facing the front of the Pocket PC before inserting it.



NOTE: If your expansion card is not recognized, follow the card manufacturer's instructions to install it.

Removing a Secure Digital (SD) Expansion Card



CAUTION: SD cards must first be unlocked before removal.

To remove a Secure Digital (SD) expansion card from the expansion slot on the Pocket PC:

1. Close all applications that are using the expansion card.
2. Remove a card from the Secure Digital expansion slot by **slightly pushing down on the card ①** to unlock it.



3. When the card disengages and pops out ②, pull it from the expansion slot.

Viewing the Content of Memory Cards

Use File Explorer to view the files that are located on your optional Secure Digital card.

1. From the **Start** menu, tap **Programs > File Explorer**.
2. Tap the root directory of **My Device**, and select the Storage Card folder to see a list of files and folders.

Using Inbox and Messaging

NOTE: To access Inbox Help on your device, from the **Start** menu, tap **Help > Inbox**.

Using Inbox

You can receive Internet e-mail and Short Message Service/Multimedia Message Service (SMS/MMS) messages in Inbox. Internet e-mail messages are sent by using an address you receive from your Internet service provider (ISP) or your employer. SMS/MMS messages are sent and received through your wireless phone service provider by using a phone number as the message address.

You can send and receive e-mail by synchronizing your Pocket PC with your personal computer, or by connecting to a Post Office Protocol 3 (POP3) or Internet Message Access Protocol 4 (IMAP4) mail server. You need to set up an e-mail account for each method that you use except for Microsoft ActiveSync, which is set up by default. The ActiveSync folder on your Pocket PC stores messages that you send and receive through synchronization with a personal computer. Account names appear as folders in the folder list (located on the left, under the navigation bar) in the Inbox message list.

With synchronization, messages are synchronized between the device Inbox and the personal computer Inbox by using ActiveSync and Microsoft Exchange or Microsoft Outlook.

When connecting to a POP3 or IMAP4 server, use a modem to connect to your Internet service provider (ISP), or a modem or Ethernet card to connect to the local area network that your e-mail server is connected to. You can also use your phone to connect by using a cellular line connection.

Synchronizing Inbox

After selecting Inbox for synchronization in ActiveSync, e-mail messages are synchronized as part of the general synchronization process. During synchronization:

- ❑ Messages are copied from the Inbox folder on your personal computer or the Microsoft Exchange server to the Inbox folder on your device. By default, you will receive messages from the last three days only, the first 100 lines of each new message, and file attachments of less than 100 KB in size.
NOTE: You can only synchronize information directly with an Exchange Server if your company is running Microsoft Mobile Information Server 2002 or later.
- ❑ Messages in the Outbox folder on your device are transferred to Exchange or Outlook and then sent from those programs.
- ❑ The messages on the two computers are linked. When you delete a message on your device, it's deleted from your personal computer the next time you synchronize.
- ❑ Messages in subfolders in other e-mail folders in Outlook are synchronized only if they have been selected for synchronization in ActiveSync.

For information on initiating Inbox synchronization or changing synchronization settings, see ActiveSync Help on your personal computer.

NOTE: SMS/MMS messages are not received through synchronization. Instead, they are sent to your Pocket PC via your service provider.

Using Folders

Each e-mail account, MMS account, and SMS account has its own folder hierarchy with five default folders: Inbox, Outbox, Deleted Items, Drafts, and Sent Items. The messages you receive and send through the mail account are stored in these folders. You can also create additional folders within each hierarchy. The Deleted Items folder contains messages that have been deleted on the device. The behavior of the Deleted Items and Sent Items folders depends on the Inbox options you have chosen.

The behavior of the folders you create depends on whether you are using ActiveSync, MMS, SMS, POP3, or IMAP4.

If you use ActiveSync, e-mail messages in the Inbox folder in Outlook will automatically be synchronized with your device. You can select to synchronize additional folders by designating them for ActiveSync. The folders you create and the messages you move will then be mirrored on the server. For example, if you move two messages from the Inbox folder to a folder named Family, and you have designated Family for synchronization, the server creates a copy of the Family folder and copies the messages into that folder. You can then read the messages while away from your personal computer.

If you use MMS or SMS, messages are stored in the Inbox folder.

If you use POP3 and you move e-mail messages to a folder you created, the link is broken between the messages on the device and their copies on the mail server. The next time you connect, the mail server will see that the messages are missing from the device Inbox and delete them from the server. This prevents you from having duplicate copies of a message, but it also means that you will no longer have access to messages that you move to folders created from anywhere except the device.

If you use IMAP4, the folders you create and the e-mail messages you move are mirrored on the server. Therefore, messages are available to you anytime you connect to your mail server, whether it is from your pocket PC or personal computer. This

synchronization of folders occurs whenever you connect to your mail server, create new folders, or rename/delete folders when connected.

For all accounts except ActiveSync, you can access folder options by tapping **Tools > Manage Folders**.

Setting Up an Account

To set up an account:

- ❑ To set up a POP3 or IMAP4 e-mail account, from the **Start** menu, tap **Inbox > Accounts > New Account**. Follow the instructions in the New Account Wizard.
- ❑ To set up an SMS account, from the **Start** menu, tap **Inbox > Accounts > Accounts**, and then tap **SMS**. Follow the instructions on the screen.
- ❑ To set up an MMS account, from the **Start** menu, tap **Inbox > Accounts > Accounts**, and then tap **MMS**. Follow the instructions on the screen.

To set up an e-mail account on your Pocket PC:

1. From the **Start** menu, tap **Inbox > Accounts > New Account** and enter your e-mail address.
2. Tap **Next**.
3. Enter your password and tap **Next**.
4. Check that your Account Type and Name shows a POP3 or IMAP4 connection and tap **Next**.
5. Complete the required requests on the screen and, when finished, tap **Finish**.

To connect to an e-mail account, from the **Start** menu, tap **Inbox > Accounts > Connect**.

To change options for an account:

1. From the **Start** menu, tap **Inbox > Accounts > Accounts**.
2. Tap the name of the account, and follow the instructions on the screen.

To delete an account:

1. Tap **Accounts > Accounts**.
2. Tap and hold the name of the account, and then tap **Delete**.

NOTE: You can set up several e-mail accounts including your ActiveSync account, but you can set up only one SMS and MMS account.

IMPORTANT: You cannot add a new account while connected. Tap **Accounts > Disconnect** to disconnect.

CAUTION: Do not delete your MMS Account because, if you need it later, you will not be able to add it back. For your information, you cannot delete your SMS account.

E-mail Setup

NOTE: Enter the e-mail address provided by your ISP or network administrator, such as *username@servername.com* or *username@servername.net*.

1. In **Incoming mail**, enter the name of your e-mail server.
2. In **Outgoing mail**, enter the name of your Simple Mail Transfer Protocol (SMTP) host.
3. If you are using a network connection, in **Domain**, enter your domain name.

Options

Tap **Options** to access additional settings for the following:

- Change the time intervals for downloading new messages by tapping the **Minute(s)** box and entering a new number of minutes.
- Download attachments.

- ❑ Limit the amount of messages downloaded.

NOTE: Inbox automatically picks the correct connection to use for the e-mail account you create. If you want to use a specific connection, select that connection from the Connection list. Connecting automatically may result in higher connection charges.

Some Good Tips

- ❑ To save memory, Inbox downloads e-mail message headers only instead of the whole message. To automatically download the whole message, from the list, select **Get full copy of messages**.
- ❑ When using IMAP4, to save memory, Inbox does not download attachments. To download attachments, select the appropriate option. You can also select to limit the size of messages and attachments that are downloaded to your mobile device.
- ❑ If your outgoing e-mail server (SMTP) requires authentication, select **Outgoing e-mail server requires authentication**.
- ❑ To ensure you always connect using an SSL connection, select **Require SSL connection**. Connections that use SSL allow you to send personal information safely.
- ❑ To save memory, limit the number of e-mails that are downloaded to your device by lowering the number of days to display. You can also increase this number. To change the number of days, tap the box with the number, and then change the number.

Download Messages From the Server

1. In Inbox, tap **Accounts > Connect** to open a connection to the Internet or your corporate network, depending on the account.

2. Tap **Accounts** and ensure that the account you want to use is selected (marked by a bullet).
3. Tap **Connect**. The messages on your device and e-mail server are synchronized: new messages are downloaded to the device Inbox folder, messages in the device Outbox folder are sent, and messages that have been deleted from the server are removed from the device Inbox. Tap a message in the message list to open it.
4. If you read a message and decide that you need the full copy, tap **Edit > Mark for Download** while in the message window. If you are in the message list, tap and hold the message, and then tap **Mark for Download**. This will also download message attachments if you selected those options when you set up the e-mail account. You can also choose to download full copies of messages by default.
5. When finished, tap **Accounts > Disconnect**.

NOTE: Receiving entire messages consumes storage memory.

Downloading Messages

The way you download messages depends on how you are receiving messages:

- If you receive e-mail messages through ActiveSync, begin synchronization.
- If you receive e-mail messages through a remote e-mail server, see the previous section “Download Messages From the Server.”
- MMS and SMS messages are automatically sent to you when your phone is turned on. Otherwise, messages are held by your service provider until the next time your phone is turned on.

Compose and Send a Message

1. In the message list, tap **New**.
2. To select an account, tap the **From** list and select ActiveSync, MMS, SMS, or the desired e-mail account.
3. Enter the e-mail address or SMS/MMS address of one or more recipients, separating them with a semicolon. To access addresses and phone numbers from Contacts, tap **To**.
4. Enter your message. To quickly add a canned message, tap **My Text** and tap a desired message.
5. To check spelling, tap **Edit > Spell Check**.
6. Tap **Send**. If you are working offline, the message is moved to the Outbox folder and will be sent the next time you connect.

NOTE: If you are sending an SMS message and want to know if it was received, before sending the message, tap **Edit > Options**, and select **Request SMS text message delivery notification**.

Attach a File to a Message

1. With the message open, tap **Edit > Add Attachment**.
2. Select the file you want to attach. OLE objects cannot be attached to Inbox messages.

Inbox automatically converts Pocket Word files that you attach to messages to .doc format and Pocket Excel files to .xls format.

NOTE: Files attached to SMS/MMS messages are removed from the message when sent.

Reply to or Forward a Message

1. Tap on the message to open it, tap the reply icon in the navigation bar, and then tap **Reply**, **Reply All**, or **Forward**.

2. Enter your response. To quickly add common messages, tap **My Text** and tap a desired message.
3. To check spelling, tap **Edit > Spell Check**.
4. Tap **Send**.

NOTE: Selections in the **Tools > Options > Message** tab determine whether the original text is included with the outgoing message.

Receive Attachments

Attachments sent with an e-mail message or downloaded from the server appear as an icon at the bottom of the message in its own window pane. Tapping the attachment icon opens the attachment if it has been fully downloaded. You can mark an attachment for downloading (IMAP4 account only) the next time you connect.

- If you receive messages through synchronization, start ActiveSync on your personal computer, and click **File > Mobile Device**, and then select your mobile device. Click **Tools > Options**. Select the message account, click **Settings > Include File Attachments**.
- If you receive messages through a remote e-mail server and have an IMAP4 account, in Inbox on the device, tap **Accounts > Accounts**, and then tap **IMAP4**. Tap **Next** until you reach Server Information, and then tap **Options**. Tap **Next** twice, and then select **Get full copy of messages and When getting full copy, get attachments**.

NOTE: Embedded images and OLE objects cannot be received as attachments.

An embedded message can be viewed as an attachment when using IMAP4 to receive e-mail. However, this feature does not work if TNEF is enabled so you can receive meeting requests on Microsoft Exchange Server 5.5.

Receive Meeting Requests

If you receive your e-mail messages through ActiveSync, you will automatically receive meeting requests. If you connect directly to an e-mail server, the server must be running Microsoft Exchange Server 5.5 or 2000 for you to receive meeting requests. If you are running Microsoft Exchange Server 2000, you will automatically receive meeting requests in your Inbox.

To receive meeting requests on Microsoft Exchange Server 5.5:

- ❑ Ask your system administrator to activate Rich Text Format and TNEF support for your account. If TNEF is enabled, you will not receive messages that are included in other messages as attachments, and you will not be able to tell if a message has an attachment until you get the full copy. In addition, download time may be longer.
- ❑ While setting up your mail account, select **Get file attachments**.

After you are set up to receive meeting requests:

1. If you connect directly to an e-mail server and only receive message headers and/or a limited number of lines per message, tap and hold the message that you think is a meeting request, and then tap **Mark for Download**.
2. Open the meeting request.
3. Tap the response icon () and, from the pop-up menu, tap **Accept, Tentative, or Decline**. If you want, you can also include a written message with the response. The response will be sent the next time that you synchronize or connect to your e-mail server, and your device Calendar will be updated.

Create or Change a Signature

To create or change an account signature:

1. From the **Start** menu, tap **Inbox > Tools > Options**.
2. Tap **Signatures**.

3. Select an account for which you are creating or changing a signature.
4. Select **Use signature with this account** if the check box is not already selected.
5. Select **Use when replying and forwarding** if wanted.
6. Enter a signature in the box.

NOTE: You can use a different signature with each account.

To stop using a signature, clear the **Use signature with this account** check box.

Using Messaging

Short Message Service (SMS)

SMS is the transmission of short text messages to and from a mobile phone, fax machine and/or IP address. A single SMS message should be no longer than 160 alpha-numeric characters and contain no images or graphics.

Messages longer than 160 alpha-numeric characters will be sent as multiple SMS messages. An SMS character count is visible when SMS messages (**New/Reply/Forward**) are composed. The count also shows how many SMS messages will be generated when the message is sent.

You can send Short Messages using the Phone keypad or from Inbox:

1. From the Phone keypad, tap **Tools > Send SMS**. From Inbox, tap **Accounts > SMS**.
2. Tap **New**.
3. In the **To** field, enter either the e-mail address or SMS Number of one or more recipients, separating them with a semicolon, or select a name from the contact list by tapping

the **Address Book** button in the Navigation bar. All e-mail addresses entered in the e-mail fields in Contacts appear in the Address Book.

4. Enter your message. To enter preset messages, tap **My Text** and select a message.
5. When the message is finished, tap **Send**.

NOTE: If you are working offline, the message is moved to the Outbox folder and will be sent the next time you connect.

Receiving SMS Messages

When you receive SMS messages, the e-mail icon (✉) notifies you by displaying in the Navigation bar.

NOTE: The e-mail icon (✉) also notifies you of e-mail and MMS messages.

- Tap on the e-mail icon to view the SMS message.

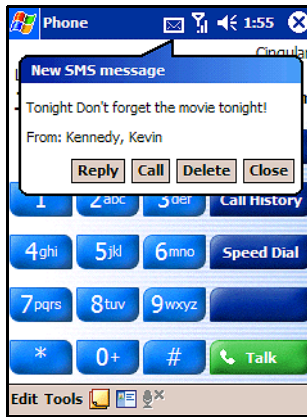









Multimedia Messaging Service (MMS)

The Multimedia Messaging Service (MMS) is a method of transmitting photographs or video clips, sound files and short text messages over wireless networks using Wireless Application Protocol (WAP).

An MMS message is created by adding various slides. Each slide may consist of a photograph or video clip, sound file, and text. The MMS Composer is located in your device's Inbox and can be accessed from the Start menu or the Today screen.

You may see the following icons displayed on the MMS Composer screens:

Icon	Definition
	Tap to preview MMS message
	Tap to send an MMS message
	Navigation buttons - Tap to navigate forward and backward
	Tap to display photos/videos as file list
	Tap to display thumbnails
	Tap to display individual photos
	Tap to select an item
	Tap to return to previous screen or cancel
	Tap to bring up Recording controls

To create an MMS slide:

1. From the **Start** menu, tap **Inbox > MMS**.
2. In the MMS Composer screen, tap **New** to create a new MMS message.

NOTE: Messages are created by combining one or more slides. Each slide can consist of a photograph or video clip, sound file, and text.

3. On the MMS Create screen, there are two pull-down lists at the top of the screen, one on the top left and one on the top right.

- a. Tap on the top left pull-down list—**Slide 1/1**—to select a specific slide for your message (remember, messages can consist of multiple slides).
 - b. Tap on the top right pull-down list—**Bottom-aligned Text**—to select the position of any added text.
4. Tap the **Tap here to insert a photo or video clip** box to choose a photo or video to be inserted.
 5. On the top, left of the next screen, tap **My Pictures** to select the specific location of the photos or videos to be inserted.
 6. On the top, right of the same screen, select either “**Photos**” or “**Videos**” from the pull-down list.



NOTE: You can only add a single photo or a single video clip to each MMS slide.

7. Tap the photo or video clip to be inserted.
8. Tap in the **Insert text here** box and enter the text to be sent, or tap the Canned Text icon to see a list of pre-saved text messages. Tap the one you want and tap the Select icon (☑).
9. Tap in the **Tap here to insert an audio clip** box to add an audio clip.

NOTE: You can either add an existing sound file, or record a new one.

10. Tap on the pull-down **My Sounds** to select a location that contains audio files.

11. Tap the audio clip to be added and tap the Select icon ().

NOTE: To preview the audio clip before selecting it, use the playback controls on the bottom of the screen. Play/Pause () and Stop () controls are available.

NOTE: To record a new audio clip, tap the diskette tape icon () to bring up controls that allow you to record new audio.

12. Tap the Send icon () to send the message.

NOTE: The MMS message will not be sent until you enter the recipient's address. See the following "Sending a Message" section for information on addressing the message.

Viewing a Message

To review a received message or preview a message that you created, you can use the playback controls (Play/Pause, Stop) on the MMS Composer screen. You can pause the message anytime during playback.

To view the slides manually, use the navigation buttons

() to scroll through the message.

Sending a Message

To send the message, you must enter the following information:

1. Enter the recipient's phone number or tap **To Phone** to view your phone book.
2. Enter the recipient's e-mail address or tap **To E-mail** to view your address book.
3. Enter the subject of the message.

4. When you're ready, tap **Send**. Otherwise, tap **Cancel**.

NOTE: If you are working offline, the message is moved to the Outbox folder and will be sent the next time you connect.

Using ActiveSync

You can use Microsoft ActiveSync to:

- Synchronize information between your HP iPAQ Pocket PC h6300 Series and up to two computers or one server so that you have the latest information in all locations.
- Change synchronization settings and the synchronization schedule.
- Copy files between your unit and computer.
- Install applications on your Pocket PC.
- Back up and restore unit information.
- Synchronize links.
- Send and receive e-mail.
- Request meetings.



CAUTION: For synchronization to work properly, install Microsoft ActiveSync on your computer **before** you connect your Pocket PC to your computer.

Connecting to a Computer

Connect your Pocket PC to your computer using Microsoft ActiveSync and the Synchronization cradle, a wireless infrared connection, a Wi-Fi connection or Bluetooth. For more information on using ActiveSync with Bluetooth, refer to Chapter 8, “Using Bluetooth.”

NOTE: When using Microsoft ActiveSync to synchronize e-mail on your computer with your Pocket PC, you must have Microsoft Outlook 98 or later installed on your personal computer. If you do not have Outlook, install the Microsoft Outlook 2002 software from the Companion CD. Microsoft Outlook Express will **not** work with the iPAQ Pocket PC and ActiveSync.

Installing ActiveSync



CAUTION: For synchronization to work properly, install Microsoft ActiveSync on your computer **before** you connect your Pocket PC to your personal computer.

To install Microsoft ActiveSync on your personal computer:

1. Insert the Companion CD into the CD tray or slot on your computer.
 2. When the CD displays on your computer screen, click on the **Start Here** tab, then select the link to install **Microsoft ActiveSync**.
-

NOTE: If the Companion CD does not automatically start on your personal computer, you may need to manually start it by clicking on the Microsoft Windows **Start** menu in the lower right corner of the monitor screen, and then clicking on **Run**. In the Run dialog box, navigate to your CD drive and double-click on **SETUP.EXE** to start the Companion CD.

3. Follow the instructions in the installation wizard. For more help, click the ActiveSync **Help** button during installation.
4. After installing ActiveSync on your computer and, when prompted, connect the Pocket PC to the computer using the Synchronization cradle.
 - a. Connect one end of the AC Adapter ❶ to the cradle and connect the other end to an electrical outlet to charge the unit.
 - b. Connect the USB connector on the cradle ❷ to the USB port on your computer.
 - c. Insert the Pocket PC in the cradle ❸.

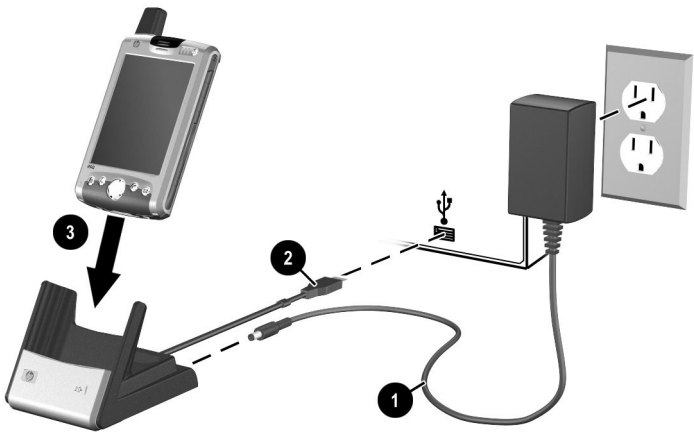

Synchronizing with Your Computer

After you have installed ActiveSync and connected your Pocket PC to your computer, you can:

- Create partnerships that enable you to synchronize information with up to two computers.

- Select information to be synchronized with your Pocket PC (for example, Contacts, Calendar, Inbox, Tasks, Favorites, Files, Notes, and AvantGo).

NOTE: When you synchronize files, you can drag and drop the selected files from your computer to the synchronized folder on your Pocket PC. If you named your device “PC1” when you created your partnership, then the synchronized folder is named “PC1.” When you synchronize, the files move to and from your Pocket PC.

Using the Serial Infrared (IR) Connection

As an alternative to using the Synchronization cradle, you can synchronize your Pocket PC and your computer using an infrared connection if you have an infrared port or an infrared USB adapter installed on your computer. The infrared connection option works only on computers that have Microsoft Windows 98SE, Me, 2000, or XP operating systems installed.

To set up an infrared connection to a computer:

1. Synchronize your Pocket PC with your computer using the Synchronization cradle **before** the first time you establish an ActiveSync connection via infrared.
2. Follow your computer manufacturer’s instructions to install and set up an infrared port.
3. Remove the Pocket PC from the cradle and line up the infrared port with the computer infrared port so they are unobstructed and within 12 inches (30.5 cm) of each other.
4. Initiate a connection by tapping **Start > ActiveSync > Tools > Connect via IR**. Synchronization begins on your device.
5. To disconnect, move the devices away from each other or tap **X** in the upper right of the screen to turn off.

Changing Synchronization Settings

You can modify your synchronization settings for Microsoft ActiveSync to:

- Change when your Pocket PC synchronizes with your computer or server.
- Change the type of connection from your Pocket PC to your computer (for example, USB or infrared connections).

NOTE: The iPAQ h6300 Series Pocket PC does not support synchronization with a personal computer using a serial cable.

- Select the files and information to synchronize with your computer.
- Select the files and information you do not want to synchronize with your computer (for example, e-mail attachments).
- Determine how conflicts between information on your Pocket PC and information on your computer are handled.

To change synchronization settings:

1. From the **Start** menu on your computer, click **Programs > Microsoft ActiveSync > Tools > Options**.
 - a. On the **Sync Options** tab, select the files and information to synchronize with your computer.
 - b. On the **Schedule** tab, select when your Pocket PC synchronizes with your computer.
 - c. On the **Rules** tab, determine how conflicts between information on your Pocket PC and information on your computer are handled.
2. Tap **OK** when you are finished.
3. From the **File** menu, click **Connection Settings**. Select the type of connection to be allowed between the Pocket PC and the computer.

Copying Files

You can copy files to and from your computer using **Explore** in ActiveSync and Windows Explorer.

To copy files:

1. Insert your Pocket PC into the Synchronization cradle.
2. From the **Start** menu on your computer, click **Programs > Microsoft ActiveSync**.
3. Click **Explore**.
4. Double-click the **My Pocket PC** icon.
5. On your computer, right-click the **Start** menu, and select **Explore**.
6. Locate the file to be moved.

NOTE: You cannot copy preinstalled files or system files.

7. Drag and drop your files between your Pocket PC and your computer. ActiveSync converts the files so that they can be used by the Pocket Office applications, if necessary.

NOTE: Move your files directly into My Documents on your Pocket PC (or into a folder inside My Documents), so the applications on your Pocket PC can locate them.

NOTE: Some files may lose some of their format during the conversion process to an application on the Pocket PC.

Installing Programs

Use ActiveSync to install programs on your Pocket PC from your computer:

1. Use the Synchronization cradle to connect your Pocket PC to your personal computer.
2. Follow the instructions in the Installation Wizard provided with the program.
3. Check the screen on your Pocket PC to see if any further steps are necessary to complete the program installation.

Backing up and Restoring

To help reduce the chance of losing information, you should back up information to your computer on your Pocket PC regularly. For more information on backing up and restoring information using Microsoft ActiveSync, refer to “Backing Up Information” in Chapter 2, “Learning the Basics.”

Synchronizing Links

You can synchronize links to Web sites from your **Favorites** list on your computer to view them offline with Pocket Internet Explorer.

1. From the **Start** menu on your computer, click **Programs** and double-click the **Internet Explorer** icon.
2. Click **Favorites** to see the list of links to your favorite Web sites.
3. To save a Web site link to Mobile Favorites, open the Web site, and click **Create Mobile Favorite**.

If you select “Favorites” as an information type to be synchronized, ActiveSync copies your mobile favorite to your Pocket PC the next time you synchronize.

4. Follow the instructions in Synchronize information to manually synchronize your favorite links.

Using ActiveSync to Send and Receive E-mail

You can send and receive e-mail messages by synchronizing your Pocket PC with your computer using ActiveSync. If you are using ActiveSync to send and receive e-mail messages, the name of the folder you are using is displayed at the bottom of the screen. For more information on sending and receiving e-mail using ActiveSync, from the **Start** menu, tap **Help > Inbox**.

Requesting Meetings

You can schedule a meeting and send a meeting request through ActiveSync. For more information, from the **Start** menu, tap **Help > Calendar**.

Managing the Battery

Your iPAQ Pocket PC is shipped with the rechargeable battery partially charged. It is recommended that you fully charge the Pocket PC battery **before** setting up the unit, and recharge regularly. Your Pocket PC uses some power to maintain files in RAM and the clock. While working at your desk, keep the Pocket PC and AC Adapter connected through the USB Synchronization Charger cradle. When you travel, it is recommended that you carry the AC Adapter, Charger Adapter plug, or an optional spare battery with you.



CAUTION: Use only an HP approved battery for your iPAQ Pocket PC. Inserting a battery that does not comply with HP requirements may cause the Pocket PC to malfunction.

The iPAQ Pocket PC also has a small internal backup battery that allows you to change the main battery without losing RAM data (user-installed programs and data) as long as it is replaced immediately. The internal battery can only be removed by qualified HP Technical Support.

Installing the Battery

To install the removable/rechargeable battery in the HP iPAQ Pocket PC h6300 Series:

1. Insert the two tabs **1** on the top of the battery into the latches in the top of the battery compartment on the back of the Pocket PC.
2. Snap the bottom of the battery into place **2**.

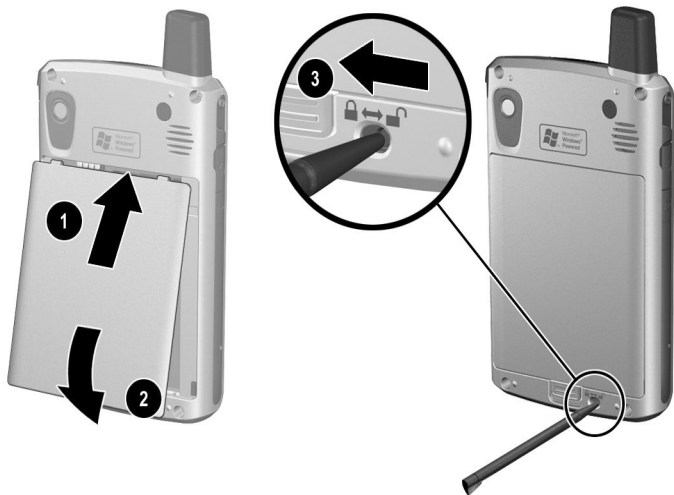

3. Insert the stylus into the battery lock **3** and slide it to the left or locked (green) position.



CAUTION: The cover must be tightly latched in place and the **battery lock must be locked** for the Pocket PC to operate. If the battery lock is not in the locked position, when you press the Power button, the Pocket PC will not power on.

NOTE: If the battery is fully discharged, you must connect the AC Adapter to the Pocket PC to fully charge it before continuing. It takes up to four hours to fully charge a completely drained battery.

Removing the Battery



CAUTION: Before removing the battery, use iPAQ Backup or ActiveSync to back up data on your Pocket PC. If you need to clear the memory during the removal process, you will be able to restore the data. To prevent losing information, you can also copy user-installed applications to the iPAQ File Store folder.



To remove the battery from the HP iPAQ Pocket PC h6300 Series:

1. Insert the stylus into the battery lock ❶ and slide it to the right or unlocked (red) position.
2. Slide the battery latch down ❷ to release the battery.
3. Remove the battery ❸.





CAUTION: Because most of the applications and data you install on your Pocket PC are held in memory (RAM), you will need to reinstall them if the battery completely discharges or if the battery is removed from the unit for more than 15 minutes. Otherwise, when fully charged, the internal backup battery will save the user installed data for up to 15 minutes when the standard battery is removed. Before removing the battery, check to see that the internal backup battery is fully charged by tapping **Start > Settings > System** tab > **Power** Icon.

You do not need to reinstall applications and data installed in the iPAQ File Store folder because they are saved in nonvolatile memory.

Charging the Battery

Battery Saving Tips:

- ❑ Leave your Pocket PC connected to AC power at all times when you're not using it.
- ❑ Set your Pocket PC to turn off after a short time if not being used.
- ❑ Set the backlight to go off quickly after you stop using your Pocket PC.
- ❑ Turn off all wireless activities when not in use.
- ❑ Turn off the "Receive all incoming beams" setting and receive infrared beams manually instead.
- ❑ You can program an Application Button to turn off the screen when an MP3 is playing, saving battery power used to run the screen. Tap **Start > Windows Media > Tools > Settings > Buttons**. From the **Select Function** drop-down list, tap **Screen Toggle**. Press either the Contacts or Inbox application buttons on the front of your iPAQ Pocket PC, then tap **OK**.
- ❑ Power off your Pocket PC when it is being charged to allow it to charge at a faster rate.

- ❑ When charging two completely discharged extended batteries simultaneously (one battery on the Pocket PC and one battery in the Synchronization cradle), turn off or suspend your Pocket PC by pressing the Power button once. This allows two drained extended batteries to be charged within eight hours.

NOTE: If the battery is completely discharged, it will power on and will trickle charge for approximately 20 minutes when it is connected to the AC Adapter or the Cradle. During this trickle charge, the device will not operate if removed from the AC power source and will not operate on main battery power. It is recommended that you leave the device connected to the AC power source long enough to power the device (approximately 30 minutes).

Charging with the AC Adapter

The standard AC Adapter works in a standard electrical outlet. You can also charge your Pocket PC in your automobile with an automobile adapter that works in your vehicle's electrical cigarette lighter or a 12-volt power outlet.

To purchase an automobile adapter, refer to the HP Web site at: www.hp.com/go/ipaqaccessories .



CAUTION: Use only HP recommended AC adapters.

To charge the iPAQ Pocket PC using the AC Adapter:

1. Insert the AC Adapter plug into the AC Charger adapter ❶.
2. Plug the AC Adapter into an electrical outlet ❷.
3. Insert the AC Charger adapter into the bottom of the Pocket PC ❸.



CAUTION: To avoid damaging your Pocket PC or the AC Adapter, check to be sure all connectors are properly aligned before connecting them.

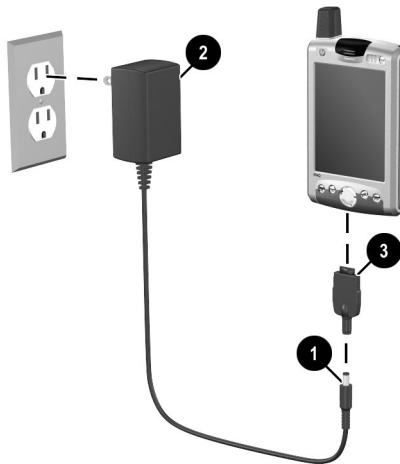

4. When the Power button indicator on the top of the Pocket PC turns solid amber, the unit is fully charged and you can disconnect the AC Adapter. The approximate time to fully charge a drained battery is four hours.

NOTE: A standard battery can be charged in about four hours, an optional extended battery takes longer.

Charging with the Synchronization Cradle and AC Adapter

Use the Synchronization Cradle to charge the HP iPAQ Pocket PC.

NOTE: It is not necessary to synchronize your Pocket PC before charging it.

To charge the Pocket PC using the cradle:

1. Plug the AC Adapter into an electrical outlet **1** and connect the other end of the AC Adapter to the AC connector on the cradle **2**.
2. Slide the bottom of your Pocket PC into the cradle **3** and push firmly to seat it.



CAUTION: To avoid damaging your Pocket PC or the cradle, check to be sure the Pocket PC and cradle connectors are properly aligned before pushing the Pocket PC into the cradle.

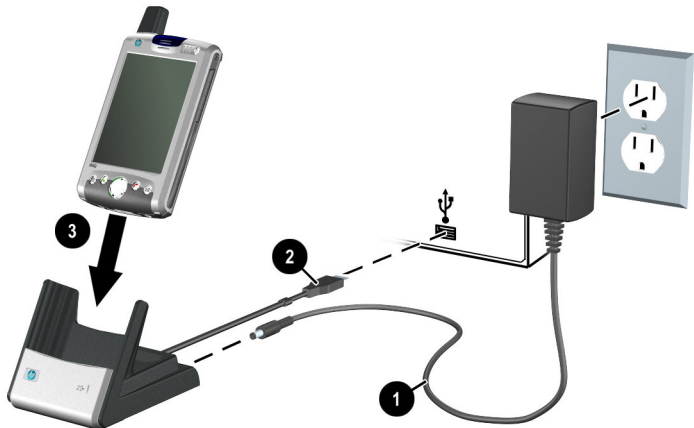

NOTE: The amber charge light on the Power button blinks while the battery is recharging and turns solid amber (nonblinking) when the battery is fully charged.

Charging Over a USB Connection

You can charge your iPAQ Pocket PC with a USB connection to a personal computer or notebook computer using the Synchronization Cradle without an AC Adapter connected, or by using an optional USB Autosync Cable. Insert the Pocket PC into the cradle and connect the cradle to your personal computer or notebook computer, or connect the Autosync Cable to the Pocket PC and your personal computer or notebook computer. The Pocket PC will charge using power from the computer.

NOTE: HP recommends that you power off your iPAQ Pocket PC while using the USB charging feature. If your Pocket PC is powered on, your device will consume more current than is being supplied by the USB charging and the main battery will not be charged. During this state, the charging LED will not blink since it is not charging.

To enable USB charging:

1. From the **Start** menu, tap **Settings > System** tab > **Power** icon > **USB Charging** tab.
2. Select **Use USB Charging**.

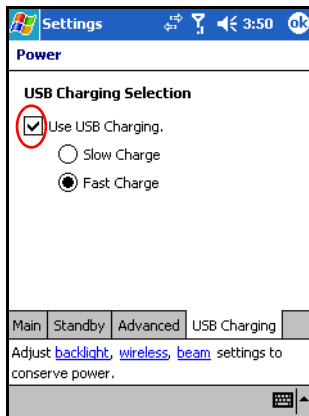

For faster charging, turn off all wireless activity and place your Pocket PC in standby mode.

NOTE: The charging indicator does not blink when the Pocket PC is turned on and being charged with a USB connection.

Charging a Spare Battery

Battery Saving Tip: To ensure you always have battery power available, you can purchase an extra Standard Battery or Extended Battery. These batteries can be charged in the Synchronization cradle. To purchase an extra battery, refer to the HP Web site at www.hp.com/products/pocketpc.

To charge an extra battery in the Synchronization cradle:

1. Plug the AC Adapter into an electrical outlet and connect the other end of the AC Adapter to the AC connector on the Synchronization cradle.
2. Insert the battery into the battery compartment **1** with the connectors on the top of the battery lined up with the connectors inside the battery compartment, and push in to seat it.

3. When the battery light on the front of the Synchronization cradle ② is amber, the battery is charging. When the light is green, the battery is completely charged and ready to use.

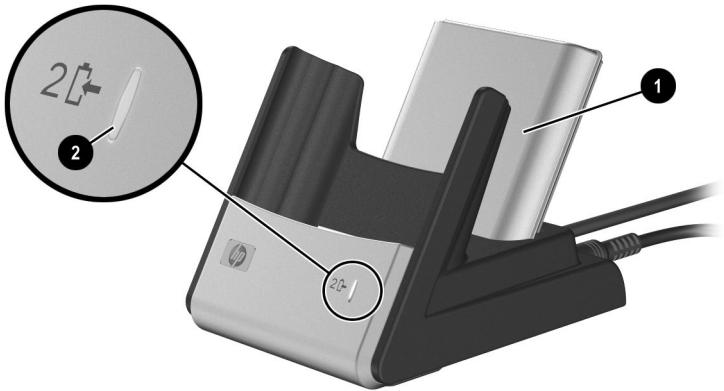

CHARGING TIP: When charging two batteries simultaneously, turn off/suspend your Pocket PC by pressing the Power button once. This allows two drained extended batteries to be charged within eight hours.

Changing the Backlight Settings

To change the backlight settings in order to conserve more battery power:

1. From the **Start** menu, tap **Settings > System tab > Backlight.**
2. Select the following backlight tabs to change the settings:
 - Battery Power
 - External Power
 - Brightness

Battery Saving Tips:

- ❑ Set the backlight to go off quickly after you stop using your Pocket PC, or move the slide bar to **Power Save** mode to turn off the backlight completely. You can also set the backlight to turn on when a button is pressed or when the screen is tapped.
- ❑ Turn off all wireless connections and Bluetooth when they are not being used.

Disabling the Application Buttons

Pressing the Contacts or Inbox Application Buttons on the front of your Pocket PC will turn your device on by default.

Battery Saving Tip: To reduce incidence of accidentally powering on the Pocket PC, you may choose to disable the Application and Record Buttons Auto Power On feature.

To disable the Auto Power On function of the Application Buttons or the Record Button:

1. Tap **Start > Settings > Personal tab > Buttons > Lock** tab.
2. Tap in the **Disable all buttons except power button** checkbox.
3. Tap **OK**.

NOTE: If you disable the Auto Power On feature for the Application Buttons, the Power Button still turns the unit on. Once the unit is turned on, all buttons will function according to their programmed functions.

Manually Monitoring the Battery

To manually monitor the battery power:

1. From the **Start** menu, tap **Settings > System tab > Power** icon.
2. Tap **OK**.

Troubleshooting

Self-Test Diagnostics

Use the Self-Test application to run tests on the operation of your device. The diagnostics application tests for sound, screen calibration, screen patterns, read/write files, IR transfer, LED notification, buttons, Wi-Fi, and GSM/GPRS.

To run the Self-Test application:

1. From the **Start** menu, tap **Settings > System** tab > **Self-Test**.
2. Place a check in the checkbox next to the items to be tested or in all checkboxes to test all of them.
3. Tap **Next**.
4. The Reset screen then prompts you to perform a reset before the tests begin. Leave the checkbox checked and tap **Start** to reset the device and start the tests. If you uncheck the box and tap **Start**, Reset will be skipped.
5. Follow the screen instructions as tests are performed on each requested item. Tap **OK** or **Cancel** as required as you proceed through the testing. If you cancel a test, the test status is set to **FAIL**.

NOTE: You will receive Error messages with specific information on items that fail. For instance, if you checked Wi-Fi and it is not working properly, you could get an Error message that says something like the following: “Error detecting Wireless Fidelity.” Use the information in the Error messages to correct the device item.

6. After the last test is performed, the test result screen displays the results of all performed tests. The final status will either be PASS or FAIL. When you tap **Finish**, you will be asked if you want to create a SelfTest log file.
 - ❑ Tap **Yes** to create the log file in My Documents folder. The log file will contain the results of the test with a time and date stamp.
 - ❑ Tap **No** to skip the log file output.
7. Tap **OK** to end the program.

Common Problems

You can use the following suggestions to troubleshoot problems with your iPAQ Pocket PC.

Problem	Solution
I cannot see anything on the screen.	<ul style="list-style-type: none"> ■ Be sure the Pocket PC is powered on. ■ Be sure the Pocket PC is connected to the AC Adapter and the Synchronization cradle. ■ Reset the device by using the stylus to lightly press the Reset button. ■ Remove and replace the battery.
I cannot keep my battery charged.	<ul style="list-style-type: none"> ■ Always keep the Pocket PC connected to the AC Adapter when you are not using it. ■ Tap Start > Settings > System tab > Power > backlight settings. In backlight settings, adjust the bar to a lower level to conserve more battery power. ■ Tap Start > Settings > System tab > Power > Advanced tab. In battery power settings, set the battery power To turn off device if not used for 2 minutes. ■ Turn off the Phone, Bluetooth, and all wireless connections when not in use. ■ Check to make sure you are using an HP authorized battery.

Problem	Solution (<i>Continued</i>)
Unit will not turn on.	<p>Make sure the battery lock is in the locked position and try to turn it on again. If it still does not turn on, try one or all of the following:</p> <ol style="list-style-type: none"> 1. Remove and replace the battery and wait for the unit to power on. 2. Reset the unit. Refer to the information on Resetting the Unit in Chapter 1, "Getting To Know Your iPAQ Pocket PC." 3. Connect the unit to the AC Adapter connected to an electrical outlet or to your connected Synchronization cradle to recharge the battery. <p>NOTE: After you have tried the above solutions and your iPAQ Pocket PC still does not turn on, contact your HP Help support by referring to the telephone numbers listed in the Worldwide Telephone book included with your Pocket PC.</p>
The backlight keeps turning off.	<p>In Backlight Settings, increase the amount of time the backlight stays on if not in use. From the Start menu, tap Settings > System tab > Backlight icon.</p>
Message displays on the Pocket PC screen that the battery is not recognized.	<p>In this event, the Pocket PC uses the remaining power available in the battery, but the battery will not charge and the charging LED will not blink. It is recommended that you back up information stored on your Pocket PC and purchase an HP authorized battery.</p>
Message displays on the Pocket PC screen that the battery temperature is out of range.	<p>The Pocket PC goes into a suspend mode and battery charging is prohibited. The device will not operate until the battery is within the acceptable temperature range (32° to 104° F). Remove the Pocket PC from extreme hot or cold environmental conditions.</p>

Problem	Solution (<i>Continued</i>)
I want to ship my Pocket PC to a repair facility.	<ol style="list-style-type: none"> 1. Back up your information to a memory card or external source for safekeeping. 2. Disconnect all external devices. 3. Pack your Pocket PC and any external devices in protective packaging as requested by Customer Support. Include any additional documentation or items as instructed by Customer Support.
I cannot connect to a network.	<ul style="list-style-type: none"> ■ Be sure you have added the necessary server information. ■ Be sure the network you are attempting to connect to is available and not busy. ■ Check the signal strength. ■ Be sure your user name and password are correct. ■ Tap Start > Settings > Connections tab > Connections and check your connection settings. Tap OK when you are finished to save your changes. ■ Be sure the WEP key is correct. ■ Be sure the IP Address is correct. ■ Reset the device by using the stylus to lightly press the Reset button. ■ Check with your service provider for current connection problems. ■ Run the self-test diagnostics.
When I try to open the Inbox, I receive an error or the application hangs.	<ul style="list-style-type: none"> ■ Check to see if your wireless application is turned on and you are receiving a wireless signal. ■ Check to see if your SIM card is inserted in your Pocket PC. ■ Limit the number of e-mail services you create.
I get an error when I try to record a note in Calendar or in Tasks.	<p>Try using a more compressed recording format in Calendar or Tasks (8,000 Hz, Mono [8 KB/s] is the most compressed format available). To switch to a more compressed recording format, from the Today screen, tap Start > Settings > Input > Options tab.</p>

Problem	Solution (<i>Continued</i>)
I want to see the current date.	<ol style="list-style-type: none"> 1. From the Today screen, tap Start > Calendar. 2. Tap the Go-to-Today icon to see today's date.
I cannot see all my appointments.	Be sure the appointment you created is in the selected category.
I cannot find the document or workbook I saved.	<p>Pocket Word and Excel recognize and display documents in only one folder below My Documents. For example, if you created another folder in the Personal folder in My Documents, the documents in that folder will not be shown.</p> <p>To find your document or workbook, tap Start > Programs > File Explorer. Open the folder you created, then tap the file you're looking for.</p>
My device is always asking me for a password.	Tap Start > Settings > Personal tab > Password to be sure the password settings are configured as you wish.
I cannot find files sent to me by another device.	Check My Documents, which is the default save location used to receive files.
Screen freezes, responds slowly, or no response.	Try resetting your Pocket PC. Refer to the information on Resetting the Unit in Chapter 1, "Getting to Know Your HP iPAQ Pocket PC."

Problem	Solution (<i>Continued</i>)
Stylus taps have inappropriate or slow response.	Realign the screen. From the Start menu, tap Settings > System tab > Screen > Align Screen , and follow the instructions.
My device keeps running out of memory.	<ul style="list-style-type: none"> ■ Move programs or data to a memory storage card such as an SDIO or MMC expansion card. ■ Set some programs (such as Notes or Pocket Word) to automatically save new files on the expansion card. ■ Move e-mail attachments to the expansion card. ■ Delete old or unnecessary files by tapping Start > Programs > File Explorer. Tap and hold the file, then from the Pop-up menu, tap Delete. ■ Remove programs you do not use by tapping Start > Settings > System tab > Remove Programs. Tap the program to be removed and then tap Remove. ■ Clear program memory by tapping Start > Settings > System tab > Memory > Running Programs tab. Tap the programs to be cleared and then tap Stop.

ActiveSync

For more information on Microsoft ActiveSync, refer to Chapter 10, “Using ActiveSync.”

Problem	Solution
<p>I cannot connect to my computer using the Synchronization Cradle.</p>	<ul style="list-style-type: none"> ■ Be sure you have installed Microsoft ActiveSync 3.7 or a later version on your host computer before connecting your iPAQ Pocket PC to it. ■ Be sure your Pocket PC is connected to the Synchronization Cradle, and that the cradle is connected to your computer. ■ Be sure your Pocket PC is securely seated in the cradle and is making contact with the cradle connector. ■ Be sure you are running Microsoft Windows 98SE, Me, 2000, or XP and that you have installed Microsoft ActiveSync 3.7 or a later version on your computer. Also be sure you are connecting directly to a USB port on your computer and not through a USB hub. ■ Try resetting your Pocket PC. Refer to the information on Resetting the Unit in Chapter 1, “Getting to Know Your HP iPAQ Pocket PC.” ■ Uninstall and reinstall ActiveSync. ■ If you are running personal firewall software, try disabling it. If you are then able to synchronize, contact the software vendor for information on configuring the required exclusions to eliminate this problem.
<p>I connected my Pocket PC before installing Microsoft ActiveSync.</p>	<ol style="list-style-type: none"> 1. Disconnect the Pocket PC from your computer. 2. In Windows 98 or 2000, click Start > Settings > Control Panel > System. The Device Manager opens automatically. Locate and select the “unknown” USB device record and click Remove (Uninstall in Windows 2000). 3. Restart your computer and allow it to detect the USB device. 4. Install Microsoft ActiveSync 3.7 or higher. 5. Reconnect the Pocket PC to the computer.

Problem	Solution (<i>Continued</i>)
<p>Microsoft ActiveSync cannot locate my Pocket PC when I synchronize.</p>	<ul style="list-style-type: none"> ■ Be sure the device is on and the charging/communications port on the bottom of the Pocket PC is connected to the communications port in the Synchronization cradle. ■ Be sure all cables are securely connected. ■ Remove your Pocket PC from the Synchronization cradle or disconnect it from the Autosync cable, power on the unit by pressing the Power button, then put it back in the Synchronization cradle or reconnect it to the Autosync cable. ■ Reset the device by using the stylus to lightly press the Reset button. ■ Check Connection Settings in ActiveSync on your computer to ensure the communications port you are using is active.
<p>I cannot open e-mail in the Inbox after I restore using Microsoft ActiveSync.</p>	<p>Use Microsoft ActiveSync to synchronize your Pocket PC with your computer. For more information, refer to the “Synchronizing with Your Computer” section in Chapter 12, “Using ActiveSync.”</p>
<p>I tried to synchronize a workbook and the file is unresolved in Microsoft ActiveSync.</p>	<p>Pocket Excel does not support all Excel formatting; therefore, Microsoft ActiveSync cannot synchronize the file.</p>

Phone

For more information on using the Phone, refer to Chapter 4, “Using the Phone Features.”

Problem	Solution
Phone will not turn on.	<ul style="list-style-type: none"> ■ Check to see if your SIM card is inserted in the Pocket PC. ■ Be sure the battery in your Pocket PC is charged. ■ If the Pocket PC is powering on and the phone still does not turn on, contact your mobile phone service provider for help.
I am unable to dial out or receive incoming phone calls.	<ul style="list-style-type: none"> ■ Check to see if your SIM card is inserted in the Pocket PC. ■ Make sure your wireless connection to your mobile service provider is turned on and your unit displays the appropriate signal strength. ■ Is the signal strength icon () displaying a diminished number of vertical bars in the icon? If so, you may be in an area outside of the phone network. ■ You may need to change the band frequency. ■ If you still cannot dial out or receive phone calls, contact your mobile service provider for help.
Phone cuts off in the middle of phone conversations.	Be sure the battery on your Pocket PC is fully charged.

Problem	Solution (<i>Continued</i>)
Phone runs out of memory.	<p>Pocket PC automatically manages the allocation of memory between storage and program memory. When memory is low, try the following:</p> <ul style="list-style-type: none"> ■ Move data to a storage card. ■ Move e-mail attachments to a storage card. ■ Delete e-mail or files no longer needed. ■ In Internet Explorer options, delete all files and clear history. ■ Delete old or unnecessary files by tapping Start > Programs > File Explorer. Tap and hold the file, then from the Pop-up menu, tap Delete. ■ Remove programs no longer used by tapping Start > Settings > System tab > Remove Programs. Tap the program to be removed and then tap Remove. ■ Clear program memory by tapping Start > Settings > System tab > Memory > Running Programs tab. Tap the programs to be cleared and then tap Stop.

Expansion Cards

For more information on expansion cards, refer to Chapter 10, “Expansion Cards.”

Problem	Solution
My Pocket PC does not recognize the SD expansion card.	<ul style="list-style-type: none"> ■ Be sure you have firmly pushed the SD expansion card into the Pocket PC. ■ Be sure any third party drivers are installed. ■ Reset the device by using the stylus to lightly press the Reset button on the left side of the iPAQ Pocket PC.
I cannot insert my SD card.	<ul style="list-style-type: none"> ■ Be sure the label is facing the front of the unit. ■ Be sure you are not inserting the card at an angle. ■ Be sure you insert the connection area first.
I cannot remove my SD card.	Push the SD card in to release the locking mechanism. The card will pop out slightly and can then be easily removed.

Bluetooth

For more information on Bluetooth, refer to Chapter 8, “Using Bluetooth.”

Problem	Solution
I cannot discover another device.	<ul style="list-style-type: none"> ■ Be sure Bluetooth is turned on. ■ Move closer to the device. ■ Be sure you have not limited your ability to see devices. ■ Be sure the device you are attempting to connect to is on and allows access to being discovered by other devices.
I can see other devices, but I cannot connect or exchange data with them.	<ul style="list-style-type: none"> ■ Be sure Bluetooth is turned on. ■ Move closer to the device. ■ Be sure the other device has not restricted your access. ■ Try initiating pairing from the other device. Some Bluetooth-enabled device can only initiate pairing and cannot respond to pairing requests from other devices.
Other devices cannot find or connect to my device.	<ul style="list-style-type: none"> ■ Be sure Bluetooth is turned on. ■ Move closer to the device. ■ Be sure you have not restricted other devices from finding yours. ■ Check your Bluetooth settings to ensure you have allowed your device to be discovered and others to connect.
Other devices do not receive my correct business card information.	<ul style="list-style-type: none"> ■ Be sure you have correctly set up your business card information in Bluetooth Settings. ■ Check Bluetooth Settings to be sure you have not restricted this function.
The Pocket PC cannot find my Bluetooth-enabled Mobile phone.	<ul style="list-style-type: none"> ■ Be sure your mobile phone is in discoverable mode. ■ Contact your mobile phone manufacturer and ask if there is a firmware upgrade.

Wireless Fidelity

For more information on Wi-Fi, refer to Chapter 7, “Using Wi-Fi.”

Problem	Solution
I cannot connect to an access point.	<ul style="list-style-type: none"> ■ Be sure the Wi-Fi is on. ■ Be sure the device identified the network you want to connect to. ■ Be sure you provided any necessary authentication keys if prompted by the system. ■ Be sure your Pocket PC is within range of an access point.
I am connected to an access point, but I cannot browse the Internet.	<p>If the wireless network you are connected to connects to Work, the network may require a proxy. To set up the proxy:</p> <ol style="list-style-type: none"> 1. Ask your network administrator for the proxy settings. 2. Tap the Connections icon > Add Proxy Server. 3. Refer to “Setting Up Proxy Server Settings” in Chapter 4 for more information.
I do not see my wireless network on my Pocket PC.	<p>Your wireless network could be a non-broadcasting network.</p> <ol style="list-style-type: none"> 1. Tap the Connections icon > Settings. 2. Tap the Advanced tab > Network Cards > Add New Settings. 3. Follow the instructions on the screen. <p>SHORTCUT: From the Today screen, tap the iPAQ Wireless icon in the Command bar, then:</p> <ul style="list-style-type: none"> <input type="checkbox"/> Tap the Wi-Fi button > Settings <input type="checkbox"/> Tap Add New . . . and enter Network name. <input type="checkbox"/> Follow the instructions on the screen.

Problem	Solution (<i>Continued</i>)
I cannot turn Wi-Fi on.	<ul style="list-style-type: none"> ■ Be sure you have enough battery charge. If the battery is low, your Pocket PC will not turn on Wi-Fi in order to conserve power. ■ Reset the device by using the stylus to lightly press the Reset button.
I cannot connect to an available network with no name.	<ol style="list-style-type: none"> 1. Tap Start > Settings > Connections tab > Connections > Advanced tab > Network Card. 2. Select Add New Settings. 3. Enter the network name (SSID). 4. Select the appropriate values in the Connects to: box. 5. If WEP settings are required, tap the Authentication tab and enter them.

Regulatory Notices

Federal Communications Commission Notice

This equipment has been tested and found to comply with the limits for a Class B digital device, pursuant to Part 15 of the FCC Rules. These limits are designed to provide reasonable protection against harmful interference in a residential installation. This equipment generates, uses, and can radiate radio frequency energy and, if not installed and used in accordance with the instructions, may cause harmful interference to radio communications. However, there is no guarantee that interference will not occur in a particular installation. If this equipment does cause harmful interference to radio or television reception, which can be determined by turning the equipment off and on, the user is encouraged to try to correct the interference by one or more of the following measures:

- Reorient or relocate the receiving antenna
- Increase the separation between the equipment and receiver
- Connect the equipment into an outlet on a circuit different from that to which the receiver is connected
- Consult the dealer or an experienced radio or television technician for help

Modifications

The FCC requires the user to be notified that any changes or modifications made to this device that are not expressly approved by Hewlett-Packard Company may void the authority to operate the equipment.

Cables

Connections to this device must be made with shielded cables with metallic RFI/EMI connector hoods in order to maintain compliance with FCC Rules and Regulations.

Declaration of Conformity for products marked with the FCC logo—United States only

This device complies with Part 15 of the FCC Rules. Operation is subject to the following two conditions: (1) this device may not cause harmful interference, and (2) this device must accept any interference received, including interference that may cause undesired operation.

For questions regarding your product, contact:

Hewlett-Packard Development Company, L.P.
P. O. Box 692000, Mail Stop 530113
Houston, Texas 77269-2000

Or, call 1-800-652-6672

For questions regarding this FCC declaration, contact:

Hewlett-Packard Development Company, L.P.
P. O. Box 692000, Mail Stop 510101
Houston, Texas 77269-2000

Or, call (281) 514-3333

To identify this product, refer to the Part, Series, or Model number found on the product.

Canadian Notice

This Class B digital apparatus meets all requirements of the Canadian Interference-Causing Equipment Regulations.

Avis Canadien

Cet appareil numérique de la classe B respecte toutes les exigences du Règlement sur le matériel brouilleur du Canada.

Japanese Notice

この装置は、情報処理装置等電波障害自主規制協議会（VCCI）の基準に基づくクラスB情報技術装置です。この装置は、家庭環境で使用することを目的としていますが、この装置がラジオやテレビジョン受信機に近接して使用されると、受信障害を引き起こすことがあります。

取扱説明書に従って正しい取り扱いをして下さい。

Korean Notice

B급 기기 (가정용 정보통신기기)

이 기기는 가정용으로 전자파적합등록을 한 기기로서 주거지역에서는 물론 모든지역에서 사용할 수 있습니다.

European Union Notice

Radio product for indoor use in Home and Office environment operating in the 2.4 GHz band—Wireless Local Area Network (WLAN).



Declaration of Conformity

This product complies with the following EU Directives:

- Low Voltage Directive 73/23/EEC
- EMC Directive 89/336/EEC
- R&TTE Directive 1999/5/EC

CE Compliance of this equipment is valid only if powered with an HP-provided and CE marked AC Adapter.

Compliance with these directives implies conformity to the following European Norms (in parentheses are the equivalent international standards and regulations):

- EN 55022 (CISPR 22)—Electromagnetic Interference
- EN 55024 (IEC61000-4-2, 3, 4, 5, 6, 8, 11)—Electromagnetic Immunity
- EN61000-3-2 (IEC61000-3-2)—Power Line Harmonics
- EN61000-3-3 (IEC61000-3-3)—Power Line Flicker
- EN 60950 (IEC 60950)—Product Safety
- ETS 300 328-2—Data transmission equipment operating in the 2.4 GHz ISM band and using 2.4 GHz radio equipment using spread spectrum techniques
- EN 301 489-1, -7, -17—General EMC requirements for radio equipment

- EN 50360/EN 50361—Technical requirements for human exposure to electromagnetic fields

The radio functionality of this equipment may be used in the following EU and EFTA countries: Austria, Belgium, Cypress, Czech Republic, Denmark, Estonia, Finland, France, Germany, Greece, Hungary, Iceland, Ireland, Italy, Latvia, Liechtenstein, Lithuania, Luxembourg, Malta, Netherlands, Norway, Poland, Portugal, Slovak Republic, Slovenia, Spain, Sweden, Switzerland, and United Kingdom.

Notice for Use in France and Italy

France:

L'utilisation de cet équipement (2.4GHz Wireless LAN) est soumise a certaines restrictions: Cet équipement peut être utilisé à l'intérieur d'un bâtiment en utilisant toutes les fréquences de 2400 à 2483.5MHz (Chaîne 1-13). Pour une utilisation en environnement extérieur, vous devez utiliser les fréquences comprises entre 2454-2483.5MHz (Chaîne 10-13). Pour les dernières restrictions, voir <http://www.art-telecom.fr>.

For 2.4 GHz Wireless LAN operation of this product, certain restrictions apply: This equipment may be used indoor for the entire 2400-2483.5 MHz frequency band (channels 1-13). For outdoor use, only 2454-2483.5 MHz frequency band (channels 10-13) may be used. For the latest requirements, see <http://www.art-telecom.fr>.

Italy:

E' necessaria una concessione ministeriale anche per l'uso del prodotto. Verifici per favore con il proprio distributore o direttamente presso la Direzione Generale Pianificazione e Gestione Frequenze.

License required for use. Verify with your dealer or directly with General Direction for Frequency Planning and Management (Direzione Generale Pianificazione e Gestione Frequenze).

Battery Warning



WARNING: This iPAQ Pocket PC contains a LITHIUM-ION rechargeable battery. To reduce the risk of fire or burns, do not disassemble, crush, puncture, short external contacts, or dispose of in fire or water. Replace only with the HP battery pack Spare Part Number 355913-001.



CAUTION: Risk of explosion if battery is replaced by an incorrect type. Dispose of used batteries according to the instructions.



Because of the type of battery used in your iPAQ Pocket PC, follow local regulations regarding the safe disposal of the battery. Your vendor can advise you on local regulations, and/or the existence of any battery disposal programs in operation.

Taiwan Battery Recycling Notice



廢電池請回收

Equipment Warning



WARNING: To reduce the risk of personal injury, electrical shock, fire or damage to the equipment:

- Plug the AC Adapter into an electrical outlet that is easily accessible at all times.
 - Disconnect power from the equipment by unplugging the AC Adapter from the electrical outlet.
 - Do not pull on power cables. When unplugging from the electrical outlet, grasp the AC Adapter and pull out from the electrical outlet.
 - Do not place anything on the power cables. Arrange them so that no one may accidentally step on or trip over them.
-

Airline Travel Notice

Turn off your Pocket PC before boarding any aircraft. Federal Aviation Administration (FAA) regulations require you to have permission from a crew member to use the phone features on your Pocket PC while the plane is on the ground. To prevent interference with wireless systems, local Radio Frequency (RF) regulations prohibit using the phone features on your Pocket PC while the plane is in the air. Use it on the ground only with crew permission. Use of the Pocket PC features other than the phone is at the discretion of the airline.

Medical Electronic Equipment

If you have a medical condition that requires you to use a pacemaker, hearing aid, or any type of medical electronic equipment, consult the manufacturer of the equipment to determine if the medical equipment is shielded from RF energy. Turn off your Pocket PC in health care facilities or hospitals when there are posted restrictions requiring you to do so.

Wireless Notices

In some environments, the use of wireless devices may be restricted. Such restrictions may apply aboard airplanes, in hospitals, near explosives, in hazardous locations, etc. If you are uncertain of the policy that applies to the use of this device, please ask for authorization to use it prior to turning it on.

U.S. Regulatory Wireless Notice



WARNING: Exposure to Radio Frequency (RF) Radiation
The radiated output power of this device is below the FCC radio frequency exposure limits. Nevertheless, the device should be used in such a manner that the potential for human contact during normal operation is minimized. To avoid the possibility of exceeding the FCC radio frequency exposure limits, human proximity to the antenna should be minimized. For body worn operation, this device has been tested and meets the FCC RF exposure guidelines when used with the HP accessories supplied with or designated for this product. Use of other accessories may not ensure compliance with FCC RF exposure guidelines. The long-term characteristics or possible physiological effects of Radio Frequency electromagnetic fields have not been investigated by UL.

U.S. Regulatory Notice For 900/1800 GSM Frequency Bands

This device contains 900/1800 MHz GSM functions that are not operational in U.S. territories. This filing is only applicable for GSM 850 MHz and PCS 1900 MYHz operations.

Health and Safety Information—FCC

Since your HP wireless phone is a radio transmitter and receiver, you may be exposed to Radio Frequency (RF) signals when it is powered on. However, your HP wireless phone has been designed so that it does not exceed the emission limits for exposure to radio frequency energy that are set by the Federal Communications Commission of the U.S. Government. These limits are part of comprehensive guidelines and establish permitted levels of RF

energy for the general population. The guidelines are based on the safety standards previously set by both the United States and international standards:

This equipment under test has been shown to be capable of compliance for localized Specific Absorption Rate (SAR) for uncontrolled environment/general population exposure limits specified in ANSI/IEEE Standard C95.1-1992 and had been tested in accordance with measurement procedures specified in FCC/OET Bulletin 65 Supplement C (2001) and IEEE Standard 1528-200X (Draft 6.5, January 2002). Ministry of Health (Canada), Safety Code 6. The standards include a substantial safety margin designed to assure the safety of all persons, regardless of age and health. The exposure standard for wireless mobile phones employs a unit of measure known as the Specific Absorption Rate (SAR). The SAR limit set by the FCC is 1.6W/kg.

NOTE: In the U.S. and Canada, the SAR limit for mobile phones used by the public is 1.6 watts/kg (W/kg) averaged over one gram of tissue. The standard incorporates a substantial margin of safety to give additional protection to the public and to account for any variations.

Canadian Regulatory Wireless Notice

Operation is subject to the following two conditions: (1) this device may not cause interference, and (2) this device must accept any interference, including interference that may cause undesired operation of the device.

Australian Wireless Notice



WARNING: Switch off this device whenever in an area with a potentially explosive atmosphere (i.e., service stations, chemical plants, etc.).

Japanese Regulatory Wireless Notice

この機器の使用周波数帯では、電子レンジ等の産業・科学・医療用機器のほ
 外の製造ライン等で使用されている移動体識別用の構内無線局（免許を要す
 無線局）及び特定小電力無線局（免許を要しない無線局）が運用されています。
 この機器を使用する前に、近くで移動体識別用の構内無線局及び特定小電
 力無線局が運用されていないことを確認して下さい。

万一、この機器から移動体識別用の構内無線局に対して電波干渉の事例が
 生じた場合には、速やかに使用周波数を変更するか又は電波の発射を停止し
 上、下記連絡先にご連絡頂き、混信回避のための処置等（例えば、パーティ
 ッョンの設置など）についてご相談して下さい。

その他、この機器から移動体識別用の特定小電力無線局に対して電波干渉
 事例が発生した場合など何かお困りのことが起きたときは、次の連絡先へお
 問い合わせ下さい。

連絡先：日本ヒューレット・パッカード株式会社 TEL：0120-01412

2 . 4 F H 1

2 . 4 D S 4

Brazilian Regulatory Wireless Notice

Este equipamento opera em caráter secundário, isto é, não tem
 direito a proteção contra interferência prejudicial, mesmo de
 estações do mesmo tipo, e não pode causar interferência a
 sistemas operando em caráter primário.

Singaporean Wireless Notice

- Switch off your cellular telephone when in an aircraft. The use of cellular telephones in an aircraft may be dangerous to the operation of the aircraft, disrupt the cellular network, and is illegal. Failure to observe this instruction may lead to suspension or denial of cellular services to the offender, or legal action or both.
- Users are advised not to use the equipment when at a refueling point.
- Users are reminded of the need to observe restrictions on the use of radio equipment in fuel depots, chemical plants or where blasting operations are in progress.
- The use of the Alert device to operate a vehicle's lights or horn on public roads is not permitted.
- It is advised that a handheld microphone or telephone handset should not be used by the driver while the vehicle is moving, except in an emergency. Speak only into a fixed, neck slung or clipped-on microphone when it would not distract your attention from the road.
- As with other mobile radio transmitting equipment, users are advised that for satisfactory operation of the equipment and for the safety of personnel, it is recommended that no part of the human body be allowed to come too close to the antenna during operation of the equipment.
- This device has been designed to comply with applicable requirements for exposure to radio waves based on scientific guidelines that include margins intended to assure the safety of all people, regardless of health and age. These radio wave exposure guidelines employ a unit of measurement known as the Specific Absorption Rate (SAR). Tests for SAR are conducted using standardized methods with the phone transmitting at its highest certified power level in all used frequency bands. The SAR data information is based on CENELEC's standards EN50360 and EN50361 which use

the limit of 2 W/kg averaged over 10 grams of tissue. The highest SAR value for this model phone when tested is as follows:

- GSM900: 0.652 W/kg (10g)
- PCN1800: 0.487 W/kg (10g)

Taiwanese Wireless Notice

註：

1. SAR 標準值1.6W/Kg ；
送測產品實測值GSM:900 為 0.652 W/Kg 。

PCN:1800 為0.487 W/Kg 。

2.  減少電磁波影響，請妥適使用。

Specifications

System Specifications

System Feature	Description
Processor	TI OMAP 1510
Operating System	Microsoft Windows Mobile™ 2003 Software for Pocket PC- Phone Edition
SDRAM	64-MB SDRAM (55 MB user accessible)
ROM	64-MB
iPAQ File Store (nonvolatile memory)	Up to 20-MB Storage (not available in Korean, Japanese, Traditional Chinese, and Simplified Chinese versions)
External Power	10 watt maximum output AC Adapter
Display	3.5 inch (89 mm) transfective color TFT, 240 x 320 pixels, 0.24 mm dot pitch, 64K-color support, touch screen.
LED Backlight	Multi-level brightness adjustment
SD I/O slot	Supports SDIO and SD/MMC type standard
Audio	Integrated microphone, receiver, speaker and one 3.5 mm stereo headphone jack, MP3 stereo (through audio jack and speaker) Handsfree speaker phone
Camera	Built-in VGA, 64 x 480 resolution, JPG format (not included with all models)

System Feature	Description (Continued)
Removable Keyboard	Thumb Keyboard with 26 alpha-numeric keys with 2 application buttons, Phone send and on/off buttons, and Function and Shortcut Keys (not included with all models)
Wired Ear Bud Headset	3.5 mm plug with single earbud - Included in box.
Infrared (IrDA)	IrDA, data transfer up to 115.2 Kb per second
Bluetooth	Class II device; typical 10 meters (30 feet) range
802.11b	Wireless Local Area Network
GPRS data features	Class B GPRS Multi slot Class 10, Quadband Coding Schemes: CS1 to CS4
GSM voice features	Full Rate, Enhanced Full Rate, Adaptive Multi-Rate (FR/EFR/AMR) Echo cancelation and noise reduction Full duplex hands-free
GSM Data	Circuit Switched Data - GSM Transparent and non-transparent (NT) data V.42bix data compression for GSM NT data
SIM Card	SIM standards

LED Indicators:

- Power Button LED
- Blinking green indicates Notification, tone, pop-up message.
 - Blinking amber indicates unit is charging.
 - Solid amber indicates unit is fully charged.
 - When connected to AC power, LED off indicates power to unit is off.

NOTE: Power LED does not light when the Pocket PC is disconnected from AC power.

System Feature	Description (Continued)
GSM/GPRS (Left LED)	<ul style="list-style-type: none"> ■ Blinking green indicates active GSM/GPRS connection. ■ Blinking amber indicates inactive GSM/GPRS connection. ■ LED off indicates connection to GSM/GPRS is powered Off.
Bluetooth (Middle LED)	<ul style="list-style-type: none"> ■ Blinking blue indicates Bluetooth is powered On. ■ LED off indicates Bluetooth is powered Off.
Wi-Fi (Right LED)	<ul style="list-style-type: none"> ■ Blinking green indicates active connection to Wi-Fi. ■ Blinking amber indicates inactive connection to Wi-Fi. ■ LED off indicates connection to Wi-Fi is powered Off.
Battery	Removable/rechargeable 1800 mAh, 3.7 Volt, Lithium Polymer battery with internal backup battery to maintain data during main battery replacement.

Physical Specifications

HP iPAQ h6300 Series

	US	Metric
Length	4.68 in	119.0 mm
Width	2.95 in	75.0 mm
Depth	0.73 in	18.7 mm
Weight	6.7 oz	190 g

Operating Environment

Environment

		US	Metric
Temperature	Operating	32° to 104° F	0° to 40° C
	Nonoperating	-4° to 140° F	-20° to 60° C
Relative Humidity	Operating	up to 90%	up to 90%
	Nonoperating	up to 90%	up to 90%
Maximum Altitude	Operating	15,000 ft	4,572 m
	Nonoperating	40,000 ft	12,192 m

Index

802.11b Wi-Fi network 7–1
802.1X protocols 7–19

A

AC adapter 13–5
AC Charger adapter 13–6
accent characters 3–15
ActiveSync
 installing 12–2
 synchronizing 12–4
 using 12–1
aligning screen 1–11
application buttons
 customizing 2–5
 disabling 13–11
 locking 2–6
applications
 installing 2–7
 using 2–6
Auto Power On function
 disabling 13–11

B

backing up information 2–8
backlight settings 13–10, 14–2
basics
 learning the 2–1
battery
 AC adapter 13–6

 charging the 13–4
 installing 13–2
 managing 13–1
 removing 13–3
 spare 13–9
 synchronization cradle 13–7
battery lock 13–2
Block Recognizer 3–1, 3–6
Bluetooth
 accessibility properties 8–5
 business card exchange 8–23,
 8–26
 enabling services 8–7
 services 8–3
 supported services 8–4
 terms 8–3
 using 8–1
Bluetooth Manager 8–12
 button 5–4
Bluetooth Settings 8–4
 button 5–4
business card exchange
 Bluetooth 8–23

C

call barring 4–19
call waiting 4–18
caller ID 4–18

camera
 features 9–7
 recording sound with a picture
 9–10
 resolution 9–6
 settings 9–5
 using the 9–1

charging
 battery 13–6
 spare battery 13–9
Circuit switched data 4–31
Clock Settings screen 1–5
Command bar 2–2
customizing
 application buttons 2–5
 Today screen 2–4

D
Data connectivity icon 5–4, 7–5,
 7–9

date
 setting 1–6
downloading messages 11–7
drawing and writing 3–7

E
e-mail
 account 11–4
 attachments 11–9
 managing 6–8
 messages 11–1
 synchronizing 12–2
emergency number 4–1
 dialing 4–2
encryption
 wireless 7–18
expanding memory 10–1

expansion cards 10–1

F
Favorites list 6–9
forwarding calls 4–19
frequency bands 4–7

G
GPRS 4–1, 4–30
 connection 1–10, 6–3
 switching between networks
 6–5
GPRS settings manager 4–23,
 4–24
GSM 4–1
 connection 6–4
GSM/GPRS 6–1
 data connections 4–1
 settings screen 4–26
 wireless networks 4–22

H
hard reset 1–10
headset connection 8–14
hearing-impaired 4–33
hotspots
 connecting to 7–8
HP Image Zone 9–9
HP profiles 4–9

I
icons
 clock 1–5
 phone 4–5
 status 1–12
IMAP4 e-mail server 6–8, 11–1
Inbox 11–1
Infrared (IrDA) 6–1

- input methods
 - learning 3-1
 - on-screen keyboard 3-3
 - Removable Thumb Keyboard 3-9
- input panel button 2-2
- installing programs 12-7
- installing the battery 13-2
- Internet address 6-9
- Internet connection
 - editing 4-26
- IP address 7-12
- iPAQ Backup 2-8
- iPAQ File Store 1-10
- iPAQ Wireless icon 7-5
- iPAQ Wireless manager 5-1
- iPAQ Wireless screen 5-1
 - power buttons 5-2
 - settings buttons 5-3
- K**
- keyboard
 - accent characters 3-15
 - configuring 3-13
 - connecting 3-12
 - disconnecting 3-13
 - function keys 3-14
 - on-screen 3-3
 - removable 3-9
 - removable components 3-10
- L**
- LEAP 7-20
- Letter Recognizer 3-1, 3-4
- M**
- messaging
 - MMS 11-13
 - SMS 11-11
 - using 11-11
- Microsoft Pocket PC Basics 1-1
- Microsoft Transcriber 3-5
- MMS 4-1, 4-28, 4-32, 11-1, 11-13
- mobile phone service provider 4-1
- muting a phone call 4-15
- N**
- Navigation bar 2-2
- Network Key (WEP) 7-5
- network settings 4-22
- O**
- on-screen keyboard 3-3
- operating environment B-4
- owner information 1-7
- P**
- password
 - setting 1-7
- phone
 - adjust volume 4-15
 - blocking calls 4-19
 - caller ID 4-18
 - enabling speakerphone 4-17
 - ending calls 4-13
 - features 4-3
 - forwarding calls 4-19
 - making a conference call 4-15
 - making calls 4-12
 - muting a phone call 4-15
 - on hold 4-18
 - setting ring tones 4-16
 - settings 4-21

- turning on and off 4–8
- using call waiting 4–18
- using Contacts 4–13
- using speed dial 4–14
- using the 4–1
- using voice mail 4–17
- phone icons 4–5
- phone service
 - activating 4–3
- Phone settings button 5–3
- pictures
 - e-mailing 9–12
 - printing 9–11
 - taking a 9–2
- PIN 4–4
- PIN Unblocking Key 4–4
- POP3 mail server 6–8, 11–1
- pop-up menu 2–3
- power button 1–10
- printing pictures 9–11
- proxy server settings 6–8
 - setting up 7–18
- PUK 4–4

R

- receiving calls 4–12
- Regulatory notices A–1
- Removable Thumb Keyboard 3–9
- reset
 - hard 1–10
 - soft 1–9
- reset button 1–9, 1–10
- ring tone 4–16
- ringer volume 4–20
- routine care 1–14

S

- screen
 - alignment 1–11
- Secure Digital (SD) card 10–2
- security
 - 802.1X certificate enroller 7–19
 - LEAP 7–20
 - TTLS 7–19
- Security protocol utilities
 - WLAN 7–18
- Self-Test diagnostics 14–1
- service settings 4–21
- settings buttons 5–3
- signal status 7–11
- signal strength 4–7, 7–11
- SIM card 4–1
 - activating 4–3
 - automatic detection 4–33
 - configuring your pocket pc 4–23
 - inserting 4–2
 - serial number 4–3
 - unlocking 4–4
 - using a PIN 4–4
 - using a PUK 4–4
- SIM slot 4–1
- SMS 4–1, 4–28, 4–31, 11–1, 11–11
- SMTP gateway 6–8
- soft reset 1–9
- software programs 1–1
 - ActiveSync 1–3
 - Contacts 1–3
 - HP Asset Viewer 1–1
 - HP Image Capture 1–1

- HP Image Transfer 1-1
- HP Image Zone 1-1
- Inbox 1-3
- iPAQ Backup 1-2
- iPAQ Wireless 1-2
- Microsoft ActiveSync Backup
 - 2-8
- Pocket Excel 1-3
- Pocket Internet Explorer 1-3
- Pocket Word 1-4
- Ring Tones 1-4
- Self-Test 1-2
- Windows Media Player 9
 - Series 1-4
- speakerphone 4-17
- specifications B-1
- status icons 1-12, 1-14
- stylus 3-4, 3-5
 - basic actions 1-4
- synchronization cradle 13-7
- synchronizing
 - ActiveSync 12-3
 - e-mail 12-2
 - infrared (IR) connection 12-4

T

- TCP/IP settings
 - changing 7-13
- time
 - setting 1-6
- time and date 1-5
- time zone 1-5
- Today screen 2-1
 - customizing 2-4
- Transcriber 3-1, 3-5
- traveling

- with your Pocket PC 1-15
- troubleshooting 14-1
 - ActiveSync 14-7
 - Bluetooth 14-12
 - expansion cards 14-11
 - phone features 14-9
 - Wi-Fi 14-13
- TTLS 7-19
- TTY functionality 4-33

V

- voice mailbox 4-17
- volume
 - ringer 4-20
 - system 4-20
- VPN connection 6-7
- VPN server connection
 - setting up 7-15

W

- WAP
 - browser 6-6
 - gateway 4-32
 - information 4-28
- Wi-Fi 6-1
 - access points 6-6
 - settings button 5-3
 - switching between networks
 - 6-5
 - terms 7-2
 - using 7-1
- Wi-Fi LED 7-4
- WLAN 6-1

